

# CONTI® SYNCHROFLEX Polyurethane Timing Belts Overall catalog

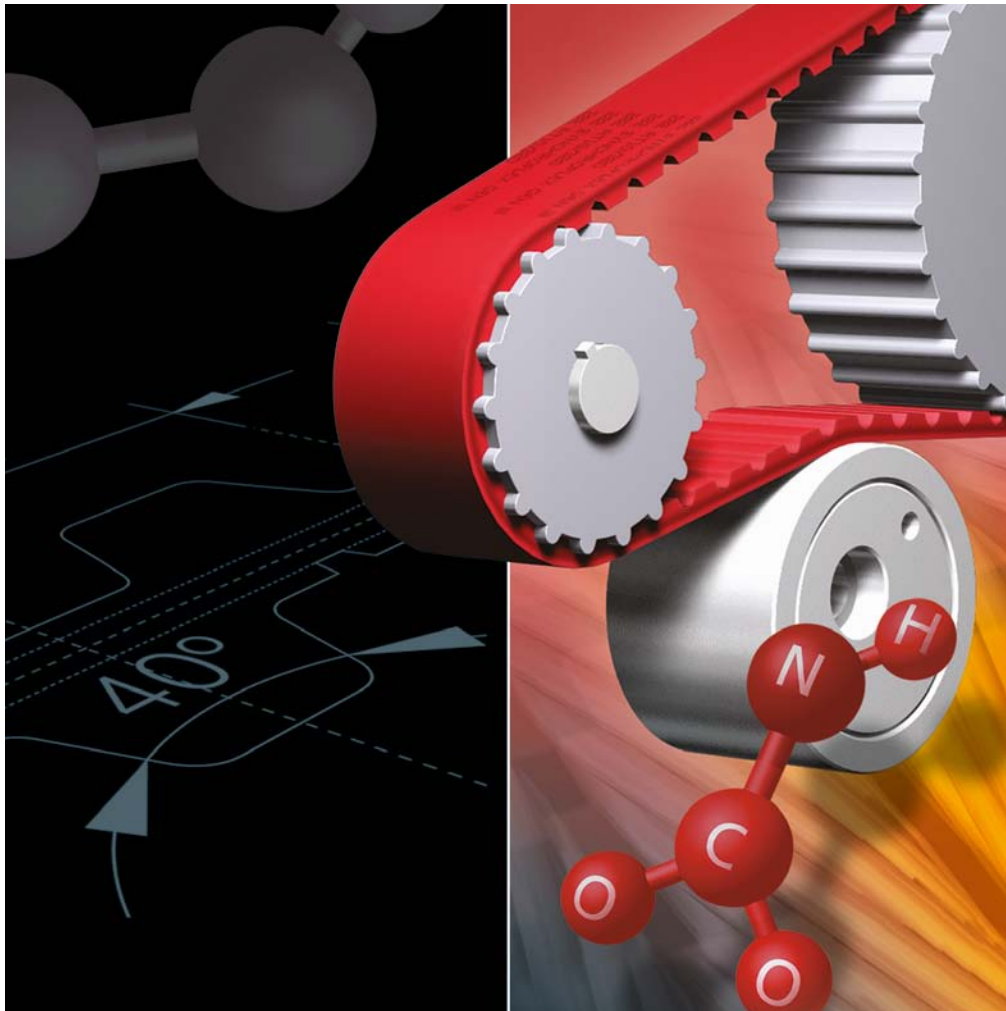

© Registered trademark of ContiTech AG

**Continental**   
**CONTITECH**

 **MULCO**®  
THE POWER OF A WELL-MESHED GROUP.

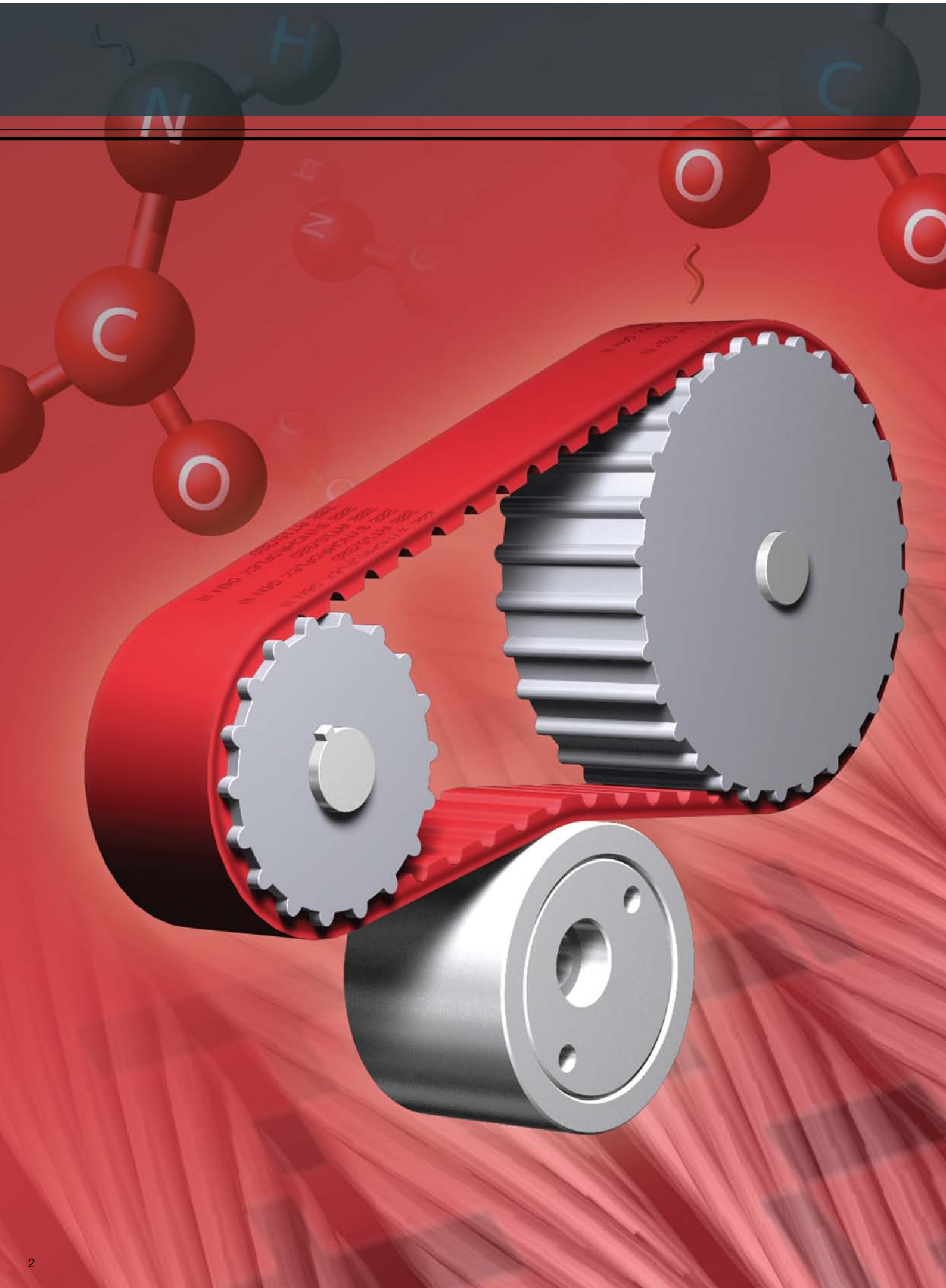

# CONTI® SYNCHROFLEX Timing Belts

## Advanced manufacture and high-performance materials combine for product excellence

CONTI® SYNCHROFLEX Polyurethane Timing Belts deliver best-in-class power transmission performance thanks to the uncompromising selection of high-grade components and the superior bonding strength between the hard-wearing polyurethane shell and the constant-length galvanised steel tension members.

The highly flexible production process is particularly suitable for manufacturing double-sided belts and high accuracy profiles on the belt back. A range of specialist compounds and materials are available to enable operation at low temperatures, in clean rooms and in the food industry.



### Content:

Page	General Information
4	Manufacturing process
5	Construction
6	Timing Belt Types
8	Antistatic CONTI® SYNCHROFLEX Timing Belts
9	“E” tension member
10	High-power version GEN III
12	Belt performance table
14	Tolerances
15	Mulco belt-pilot
16	Belt tension gauges
17	Angular drives
18	Guiding belts with flanges
19	Tooth gap shapes
20	Safety factors
21	Pre-tension force
23	Basis of calculation
	<b>AT high performance Timing Belts</b>
28	AT 3 GEN III
30	AT 3
32	AT 5 GEN III
34	AT 5
36	AT 10 GEN III
38	AT 10
40	ATP 10 GEN III
42	ATP 10
44	ATP 15 GEN III
46	ATP 15
48	AT 20 GEN III
50	AT 20
	<b>T standard Timing Belts</b>
52	T 2
54	T 2,5 / T 2,5-DL
56	T 5 / T 5-DL
58	T 10 / T 10-DL
60	T 20 / T 20-DL
	<b>Imperial Timing Belts</b>
62	M (MXL)
	<b>Serrated Profile Timing Belts</b>
64	K 1 / K 1,5
	<b>F Flat Belts</b>
66	F/AF/BF/CF/DF
	<b>Timing Belts with special tooth profiles</b>
67	V (excerpts of XL, L, H)
	<b>Special Timing Belt Versions</b>
68	Coated timing belts
76	Integrated flights
78	Brush timing belts
80	Mechanical rework
81	List of Catalogues
83	Addresses

# Manufacturing process

CONTI® SYNCHROFLEX Polyurethane Timing Belts consist of two components – a cast Polyurethane shell and a high grade steel cord tension member. The excellent bond between the two materials results in a very high power transmission capacity.

**The manufacturing process – cast moulded polyurethane – combines the following advantages:**

- The cast polyurethane timing belt is an exact image of the precision engineered mould. High pitch accuracy is achieved over the entire belt. The technology is particularly suitable for applications requiring high levels of angular accuracy, smooth running characteristics, high rotational speeds and long life.
- Excellent linearity with high pitch accuracy and repeatability allows the length to be optimised by adjusting the cord tension.
- The casting method combines with the capillary effect, producing an exceptionally high strength bond with the steel tension members.
- The high reproduction quality of the cast polyurethane process enables fine contoured features and smaller belt pitches to be moulded. Double-sided belts and profiled flights on the back of the belt can be moulded simultaneously.
- The process produces an effective belt width of up to 300 mm.
- Belt lengths from 55 mm to 6000 mm endless length.

CONTI® SYNCHROFLEX Polyurethane Timing Belts are used across a very wide range of applications for the transmission of synchronous rotary motion in power transmission systems, servo and motion controls, conveyors and transfer lines. They operate in a rotational speed range of up to 20,000 rpm.

**Applications include:**

- office machinery
- electronic data processing equipment (EDP)
- textile machinery
- wood processing machinery
- machine tools
- printing machinery
- pumps
- compressors
- building machinery

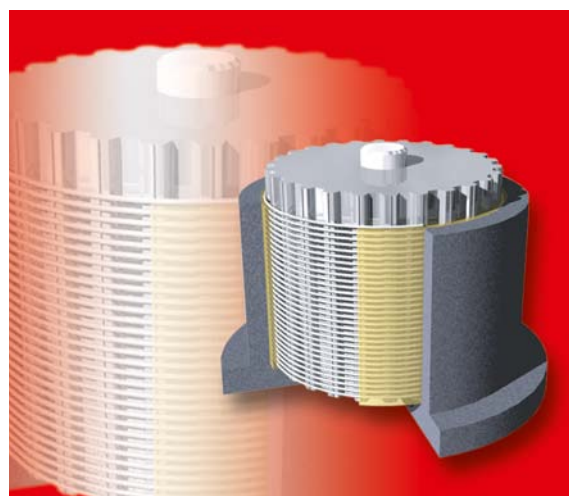
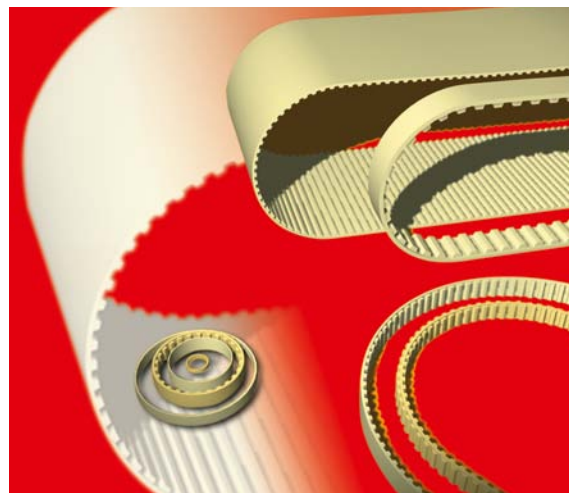

Casting mould, illustrated with a spirally wound tension member on the mould core.



Ready de-moulded timing belt sleeve, partly separated into individual belts.



# Construction

CONTI® SYNCHROFLEX Polyurethane Timing Belts are manufactured from wear resistant Polyurethane and high tensile steel cord tension members. Both high quality materials combine to form the basis for dimensionally stable and highly durable polyurethane timing belts. Polyurethane timing belts have very high longitudinal stiffness and no post-elongation of the tension members is to be expected in continuous operation. Only under extreme loading conditions and as a precaution after a brief run-in, a small loss of tension may necessitate a once-only retensioning.

The timing belts are temperature resistant with ambient temperatures from -30°C to +80°C. However, applications close to these temperature limits (< -10°C and > +50°C), may require adapted dimensioning. For specific temperature ranges, optional belt materials are available; e.g. the CONTI® SYNCHROFLEX GEN III Polyurethane Timing Belt range is temperature resistant up to +100°C. Please contact our technical specialists for this type of application.



CONTI® SYNCHROFLEX Polyurethane Timing Belts are manufactured using production methods that maintain very high tolerances to ensure a uniform load distribution during power transmission. They are equally suited for high torque transmission and precise positioning applications or the combination of both.

## Properties:

### mechanical

- positive fit, synchronous running
- constant length, no post-elongation
- low noise
- wear resistant
- low-maintenance
- highly flexible
- positional and angular accuracy
- fatigue resistant, low extension steel cord tension members
- belt speeds up to 80 ms<sup>-1</sup>
- small production quantities available
- excellent power-to-weight ratio
- low pre-tension
- low bearing loads
- permits large centre distances
- permits large transmission ratios
- high degree of efficiency, max. 98%

### chemical

- hydrolysis stabilized
- resistant to aging
- temperature resistant from -30°C to 80°C, note: CONTI® SYNCHROFLEX Polyurethane Timing Belt GEN III up to 100°C (see information in the text "Construction")
- tropical climate resistant
- resistant against simple oils, fats and petrol
- resistant to some acids and alkalines

For further information about the environmental resistance characteristics of CONTI® SYNCHROFLEX Polyurethane Timing Belts please contact your Mulco sales partner.

# Timing Belt Types

## AT High capacity profile

Further development of the T profile resulted in the AT profile. This type of belt is characterised by the larger tooth shear strength resulting from the larger tooth volume and the stronger tension members.

Further advantages:

- favourable tooth mesh
- strengthened tension members for constant pitch
- Improved performance up to 50 % as compared to the T profile
- precise transmission of movement in conjunction with synchronous pulleys with reduced or zero backlash
- reduction of meshing impacts or shocks
- compact drive dimensions

(also available in the GEN III version)

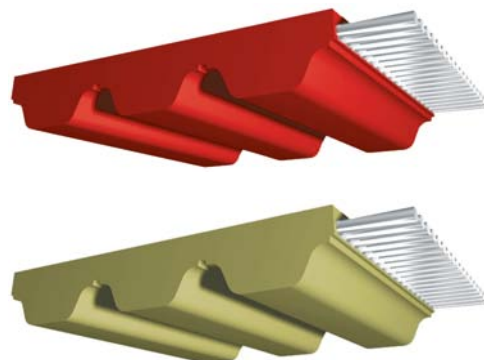

## ATP High capacity profile

Further increased performance, noise reduction and extension of the belts useful life led to the development of the ATP timing belt in 1993. At the time, the main interest was focussed on the optimum tooth form. The basic concept of the new ATP profile provides the division of the trapezoidal tooth into two individual and load bearing teeth.

Performance increase up to 60 %, running noise reduced by up to 10 db(A) and an increased longevity by:

- tooth surface area increased by 70 %
- uniform load/tension distribution
- improved power dispersion
- reduced polygon effect
- small construction width
- optimised tooth mesh

(also available in the GEN III version)

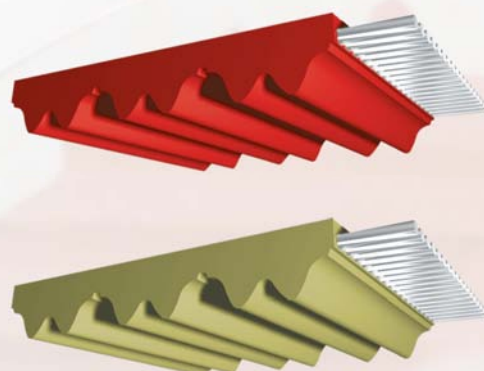

## T Standard profile

The timing belt with a trapezoidal profile according to DIN 7721 is regarded as the classical standard timing belt.

Preferred use:

- for standard drive tasks
- transmission tasks with double-sided belts
- for high bending stress
- for drives with contraflexure

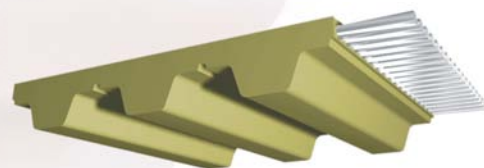

**T in DL version**

The DL timing belt (the belt is double-sided) is used in the power transmission and transport technology. Multiple-shaft drives with different rotational directions can be realised with this timing belt. Full load ability on both tooth sides.

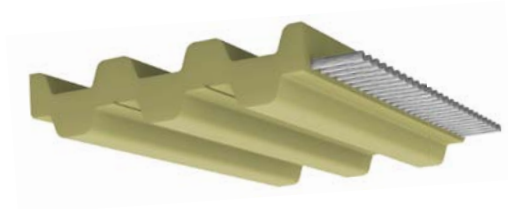
**Imperial profile**

Imperial pitches according to DIN/ISO 5296 are available in the following sizes:

M (MXL)	=	2.032 mm		
XL	=	5.080 mm	L	= 9.525 mm
H	=	12.700 mm	XH	= 22.225 mm

Preferred use:

- Applications in imperial units

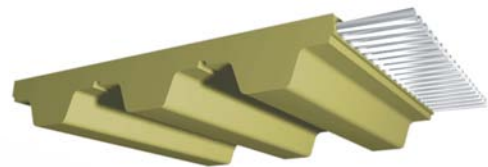
**F F Flat belts**

Preferred use:

- Friction drives (open length and endless)
- high-speed drives (CONTI® SYNCHROFLEX Belt)
- drives without synchronous transmission

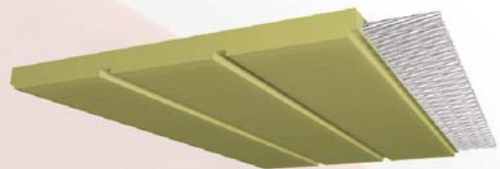
**K Serrated metric pitch profile.**

Preferred use:

- Fine mechanical technology requiring small dimensions

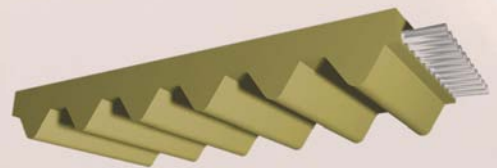
**V** The development of the PU timing belt started in 1954 with pitches other than standard.

Preferred use:

- tasks requiring special pitches
- spares

Please contact your nearest Mulco distributor to know more about our entire range of V-type belts.

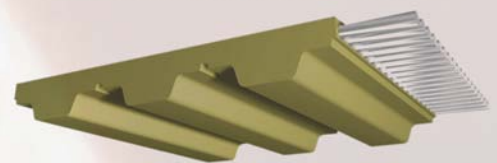

# Antistatic CONTI® SYNCHROFLEX Timing Belts

## Characteristics of CONTI® SYNCHROFLEX Antistatic Timing Belts

The antistatic properties of CONTI® SYNCHROFLEX Polyurethane Timing Belts are achieved by:

### 1. antistatic coating

A post-process application of an electrically conductive coating on all sides of the belts with or without textile facing

### 2. antistatic polyurethane mixture

A special conductive polyurethane mixture (max. belt length to 700 mm)

Other lengths on request.

Colour of antistatic timing belts: black.

### Application / Use

Antistatic CONTI® SYNCHROFLEX Polyurethane Timing Belts are used where electrostatic discharge (ESD) is not desired or is prohibited, e.g. for the transport of electronic components, for drives and/or conveying equipment in an inflammable or explosive environment.

### Electrostatic charges

The build up of static electricity, due to the continual separation of two contact surfaces, can be expected where timing belts are involved, e.g. between pulley and timing belt. This static electric charge can be considerable and may increase the danger of ignition at the moment of discharge. The value of the static electric charge is dependent on the materials used for the timing belt, synchronous pulleys, tension rollers and/or support rollers. The risk of ESD rises as the belt speed, belt tension and the contact surface width increase.

### Antistatic properties

Antistatic CONTI® SYNCHROFLEX Polyurethane Timing Belts consistently avoid the formation of static electric charges.

### Quality assurance

Conductivity is measured using test equipment meeting ISO 9563 requirements. Upon request, the wear resistance of the antistatic layer can be checked on test timing belts with an antistatic facing. Due to the fact that extended operation will result in probable surface wear, the conductivity of the antistatic timing belts may deteriorate and regular checks of the resistance values are essential. When belts are to be used in environments with a high likelihood of explosion, please contact our technical specialists for advice.

### Order example

CONTI® SYNCHROFLEX Timing Belt 25 T 5 / 630 EL-PU antistatic coated

For available lengths, please contact your Mulco sales partner.





# “E” Tension Member

## Highly flexible tension members – the “E” steel cord tension member

The smaller the diameter of each single wire, the more flexible the overall tension member is! This relationship led us to develop CONTI® SYNCHROFLEX Polyurethane Timing Belts with “E” tension members.

The cross sectional area of the “E” tension member comprises several strands of smaller diameter wires, each with excellent bending fatigue characteristics. With much improved overall flexibility CONTI® SYNCHROFLEX Polyurethane Timing Belts are particularly suited to smaller diameter pulleys and tension rollers; the minimum number of teeth and/or minimum diameter of the pulleys can be reduced by up to 30% compared with standard tension members. Timing belts with “E” tension members are recommended for multi-shaft drive applications with frequent reverse bending.

### Summary:

- smaller diameter individual wires in the steel cord
- higher dynamic capabilities
- extremely high bonding and bending fatigue strength
- smaller pulley and tension roller diameters
- runs on standard diameter timing pulleys.

For applications under extreme conditions, please contact your Mulco sales partner.

### Application information:

Steel cord tension members encapsulated in polyurethane:

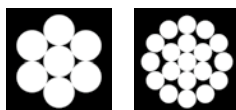

The smaller the diameter of the individual wire, the more flexible the whole timing belt.

### Available versions:

- for the pitches AT 3 (standard), AT 5 (Gen III standard), AT 10, ATP10, T 5, T 10, T 20
- all standard belt lengths for the chosen pitch
- all standard pulley sizes for the chosen pitch
- all calculations as per the standard belt chosen

### Timing belts with “E” tension members, minimum numbers of teeth:

Drive Type			AT 3 (Standard)	AT 5 (GEN III, Standard)	AT 10 ATP 10	T 5	T 10	T 20
without contraflexure 	Timing pulley	$z_{\min}$	15	12	12	10	10	12
	Tension roller (smooth), running on teeth	$d_{\min}$ [mm]	20	18	50	18	50	80
with contraflexure 	Timing pulley	$z_{\min}$	20	20	20	12	15	20
	Tension roller (smooth), running on the back of the belt	$d_{\min}$ [mm]	20	50	80	18	50	120

# High-power version GEN III

## CONTI® SYNCHROFLEX Timing Belt (SFX) AT GEN III / ATP GEN III



### A powerful basis

The combination of high tensile steel cord tension members and wear resistant polyurethane forms the basis for dimensionally stable and extremely durable high-performance timing belts. A convincing technology with excellent product features that include:

- constant length, no post-elongation
- high dimensional stability
- high-torque transmission
- quiet running
- maintenance-free
- lubrication-free
- highly chemical resistant and mechanically durable

### Each generation is different.

#### GEN III is better!

It was worth its while to focus on further developing the power drives of the AT and ATP range CONTI® SYNCHROFLEX polyurethane timing belts because the new GEN III generation excels in a 25% increase in power transmission compared with the AT/ ATP standard. Another economic bonus: all CONTI® SYNCHROFLEX GEN III polyurethane timing belts support the use of standard AT/ATP pulleys.

Mulco partners everywhere agree that advancement is synonymous to providing solutions for every product at a level of sophistication down to the smallest detail. A bifilar tension member arrangement and a higher packing density translates this into the CONTI® SYNCHROFLEX GEN III polyurethane timing belt for the AT and ATP ranges.

The high-performance polyurethane designed for dedicated use with the CONTI® SYNCHROFLEX GEN III polyurethane timing belts yields greatly improved benchmark results compared with the standard. One of the benefits is that its increased hardness allows line engineers to count on a larger number of load-carrying teeth.

**CONTI® SYNCHROFLEX GEN III – with up to 25% greater power transmission compared with the AT / ATP standard:**

- increased tensile force  $F_{zul}$  to max. +45% due to closer wound cords
- Increased power transmission  $F_{spec}$  +25%
- redesigned bifilar steel (S and Z) cord balance for better tracking
- reduced flange friction
- lower running noise with narrower belt width for equal performance
- longer life
- load bearing teeth force distribution – increased by up to 30%
- temperature range up to +100° C  
(For performance values close to the range limit, please contact your Mulco sales partner.)

Two-filament tension member arrangement

New high performance polyurethane

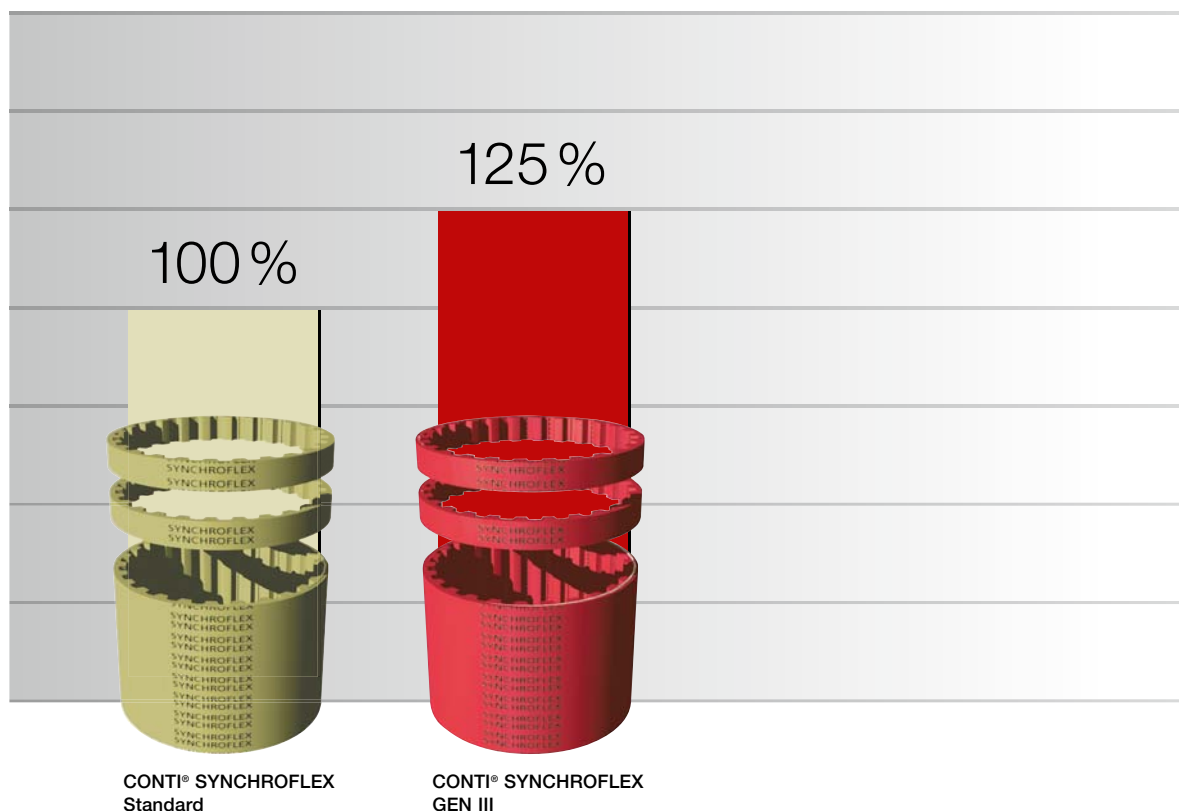
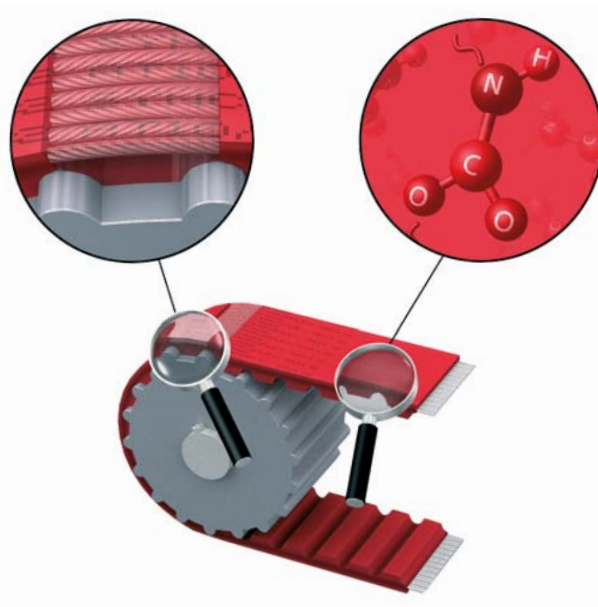

# Belt performance table

## Belt performance table

### AT 3 GEN III

Power transmission:	≤ 6 kW
Rotational speed:	approx. 20.000 min <sup>-1</sup>
Peripheral speed:	approx. 80 ms <sup>-1</sup>
Timing pulleys:	from z=15

Applications (Example): small power drives,  
Handling technology

### AT 3

Power transmission:	≤ 5 kW
Rotational speed:	approx. 20.000 min <sup>-1</sup>
Peripheral speed:	approx. 80 ms <sup>-1</sup>
Timing pulleys:	from z=15

Applications (Example): small power drives,  
Handling technology

### AT 5 GEN III

Power transmission:	≤ 18 kW
Rotational speed:	approx. 10.000 min <sup>-1</sup>
Peripheral speed:	approx. 80 ms <sup>-1</sup>
Timing pulleys:	from z=15

Applications (Example): Machine tools, Pumps,  
Textile machinery

### AT 5

Power transmission:	≤ 15 kW
Rotational speed:	approx. 10.000 min <sup>-1</sup>
Peripheral speed:	approx. 80 ms <sup>-1</sup>
Timing pulleys:	from z=15

Applications (Example): Machine tools, Pumps,  
Textile machinery

### AT 10 GEN III

Power transmission:	≤ 87 kW
Rotational speed:	approx. 10.000 min <sup>-1</sup>
Peripheral speed:	approx. 60 ms <sup>-1</sup>
Timing pulleys:	from z=15

Applications (Example): Construction machines,  
Pumps, Paper-making  
machines, Compressors  
compactors, Textile machin-  
ery, Roller-table drives

### AT 10

Power transmission:	≤ 70 kW
Rotational speed:	approx. 10.000 min <sup>-1</sup>
Peripheral speed:	approx. 60 ms <sup>-1</sup>
Timing pulleys:	from z=15

Applications (Example): Construction machines,  
Pumps, Paper-making  
machines, Compressors  
compactors, Textile machin-  
ery, Roller-table drives

### ATP 10 GEN III

Power transmission:	≤ 150 kW
Rotational speed:	approx. 10.000 min <sup>-1</sup>
Peripheral speed:	approx. 60 ms <sup>-1</sup>
Timing pulleys:	from z=15

Applications (Example): Machine tools, Textile  
machinery, Power drives

### ATP 10

Power transmission:	≤ 100 kW
Rotational speed:	approx. 10.000 min <sup>-1</sup>
Peripheral speed:	approx. 60 ms <sup>-1</sup>
Timing pulleys:	from z=15

Applications (Example): Sanding machinery,  
Power drives,  
Machine tools



**ATP 15 GEN III**

Power transmission: possible beyond 220 kW  
 Rotational speed: approx. 10.000 min<sup>-1</sup>  
 Peripheral speed: approx. 50 ms<sup>-1</sup>  
 Timing pulleys: from z=20

Applications (Example): Textile machinery,  
 Machine tools,  
 High power drives

**ATP 15**

Power transmission: possible beyond 200 kW  
 Rotational speed: approx. 10.000 min<sup>-1</sup>  
 Peripheral speed: approx. 50 ms<sup>-1</sup>  
 Timing pulleys: from z=20

Applications (Example): Power drives,  
 Machine tools

**AT 20 GEN III**

Power transmission: possible beyond 250 kW  
 Rotational speed: approx. 6.500 min<sup>-1</sup>  
 Peripheral speed: approx. 40 ms<sup>-1</sup>  
 Timing pulleys: from z=18

Applications (Example): Heavy-duty drives, Textile  
 machinery, Printing machine,  
 Machine tools

**AT 20**

Power transmission: possible beyond 200 kW  
 Rotational speed: approx. 6.500 min<sup>-1</sup>  
 Peripheral speed: approx. 40 ms<sup>-1</sup>  
 Timing pulleys: from z=18

Applications (Example): Heavy-duty drives,  
 Textile machinery,  
 Printing Machine,  
 Machine tools

**K 1,5; T 2; M; T 2,5**

Power transmission: ≤ 0,5 kW  
 Rotational speed: approx. 20.000 min<sup>-1</sup>  
 Peripheral speed: approx. 80 ms<sup>-1</sup>  
 Timing pulleys: from z=10

Applications (Example): Precision machine drives,  
 Film camera drives,  
 Positioning drives

**T 5**

Power transmission: ≤ 5 kW  
 Rotational speed: approx. 10.000 min<sup>-1</sup>  
 Peripheral speed: approx. 80 ms<sup>-1</sup>  
 Timing pulleys: from z=10

Applications (Example): Office machinery,  
 Home appliances,  
 Positioning and  
 regulating drives

**T 10**

Power transmission: ≤ 30 kW  
 Rotational speed: approx. 10.000 min<sup>-1</sup>  
 Peripheral speed: approx. 60 ms<sup>-1</sup>  
 Timing pulleys: from z=12

Applications (Example): Machine tools,  
 Main and subsidiary drives,  
 Textile machinery,  
 Printing machinery

**T 20**

Power transmission: up to approx. 100 kW  
 Rotational speed: approx. 6.500 min<sup>-1</sup>  
 Peripheral speed: approx. 40 ms<sup>-1</sup>  
 Timing pulleys: from z=15

Applications (Example): Heavy Construction machines,  
 Paper-making machines,  
 Pumps, Compressors  
 compactors, Textile machinery

**Remark:**

Special timing belt designs allow the rpm and peripheral speed parameters to be increased.

# Tolerances

## CONTI® SYNCHROFLEX Timing Belts Tolerances

### Length tolerances for standard CONTI® SYNCHROFLEX Polyurethane Timing Belts

Belt length measurement is carried out to  
DIN 7721, in relation to the centre distance.

Belt length	Length tolerance in relation to centre distance
up to 320 mm	±0,15 mm
320 – 630 mm	±0,18 mm
630 – 1000 mm	±0,25 mm
1000 – 1960 mm	±0,40 mm
1960 – 3500 mm	±0,50 mm
3500 – 4500 mm	±0,80 mm
4500 – 6000 mm	±1,20 mm

### Width tolerances for standard CONTI® SYNCHROFLEX Polyurethane Timing Belts

Type / group	up to 50 mm	50 – 100 mm	over 100 mm in % der Belt width
K 1	±0,3 mm	±0,5 mm	±0,5 %
K 1,5	±0,3 mm	±0,5 mm	±0,5 %
T 2	±0,3 mm	±0,5 mm	±0,5 %
M (MXL)	±0,3 mm	±0,5 mm	±0,5 %
T 2,5	±0,3 mm	±0,5 mm	±0,5 %
T 5	±0,3 mm	±0,5 mm	±0,5 %
T 5-DL	±0,3 mm	±0,5 mm	±0,5 %
T 10	±0,5 mm	±0,5 mm	±0,5 %
T 10-DL	±0,5 mm	±0,5 mm	±0,5 %
T 20	±1,0 mm	±1,0 mm	±1,0 %
T 20-DL	±1,0 mm	±1,0 mm	±1,0 %
AT 3	±0,3 mm	±0,5 mm	±0,5 %
AT 5	±0,5 mm	±0,5 mm	±0,5 %
AT 10	±1,0 mm	±1,0 mm	±1,0 %
ATP 10/ATP 15	±1,0 mm	±1,0 mm	±1,0 %
ATP 20	±1,0 mm	±1,0 mm	±1,0 %

#### Please note:

Tolerance for special tension members  
upon request.

# Mulco b@lt-pilot

## Your direct road to perfect design solutions

### Mulco belt-pilot – online support at [www.mulco.net](http://www.mulco.net)

Let others talk about being close to the customer, we as the market leading provider of polyurethane timing belts actually live by the idea. Mulco-Europe EWIV's secret of success has always been largely due to advising our customers before they enter the design stage. Mulco belt-pilot is taking our customer dedication a critical step further ahead. Our interactive Internet service offering enables you to calculate your personal design solutions online. Whatever field of technology you are interested in - power transmission, linear, transport or components - start Mulco belt-pilot at [www.mulco.net](http://www.mulco.net) for 24/7 access to the actual product information, CAD downloads and calculations you need.

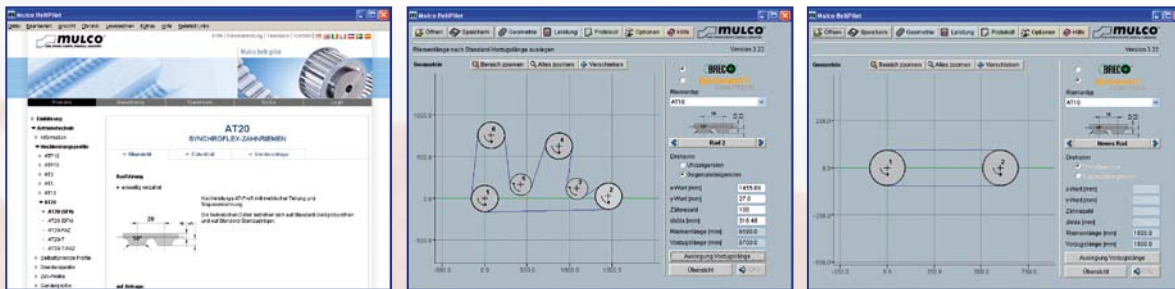

## Mulco b@lt-pilot

### Many benefits.

- ▶ Interactive service offering with video-based e-learning option
- ▶ Extensive product databases
- ▶ Free use of CAD downloads
- ▶ Import the CAD drawings into your CAD system
- ▶ Calculate timing belts, pulleys and components
- ▶ Email inquiries supported



# Belt tension gauges

## Setting the correct pre-tension force

### Clavis and SM4 belt tension gauges – simple, practical and efficient

Clavis and SM4 belt tension gauges allow you to measure the resonant frequency of a vibrating belt span. This resonant frequency directly depends on the belt tension. When starting to use or servicing a drive, these gauges are indispensable when it comes to properly adjusting the pre-tension force. A correct pre-tension force minimizes the load on the bearings, optimizes the running of the belt and, thus, extends the life of the drive. Moreover, it reduces the noise level and balances non-parallelism of wide polyurethane timing belts.



#### Clavis uses microphones to acoustically measure the frequency of the vibrating belt.

- Measuring ranges: 30 Hz ... 600 Hz (standard) and 10 Hz ... 300 Hz
- Precision: +/- 1 %
- For all polyurethane drive belt models with different tension members (e. g. steel, aramid, glass-fibre)
- Broad portfolio of replaceable sensor heads
- Integrated calibration equipment
- Battery-powered
- Steel tuning fork for fast frequency sampling included
- Ships with a calibration certificate and a case



#### Span tension gauge SM4 uses a sensor to measure the frequency of the vibrating belt.

- Measuring range: 7 Hz ... 350 Hz
- Precision: +/- 5 %
- For all polyurethane drive belt models with different tension members (e. g. steel, aramid, glass-fibre)
- Large display
- Weighs just 110 g
- Belt clip
- Battery-powered
- Ships with a transport case and protective sleeve



# Angular drives

CONTI® SYNCHROFLEX Timing Belts can be applied as angular drives. Take into consideration that the timing belt can only be crossed (twisted). Eliminates the run-off effect.

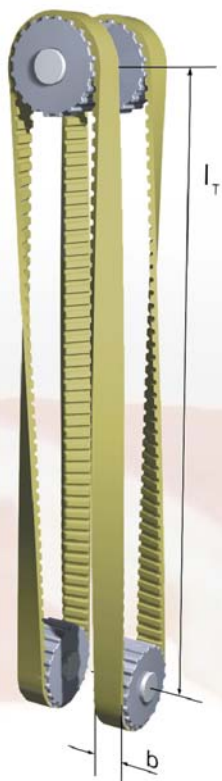

Angular drive with 2 axes

$$l_T/b \geq 20$$

$b$  = Belt width  
 $l_T$  = Span length

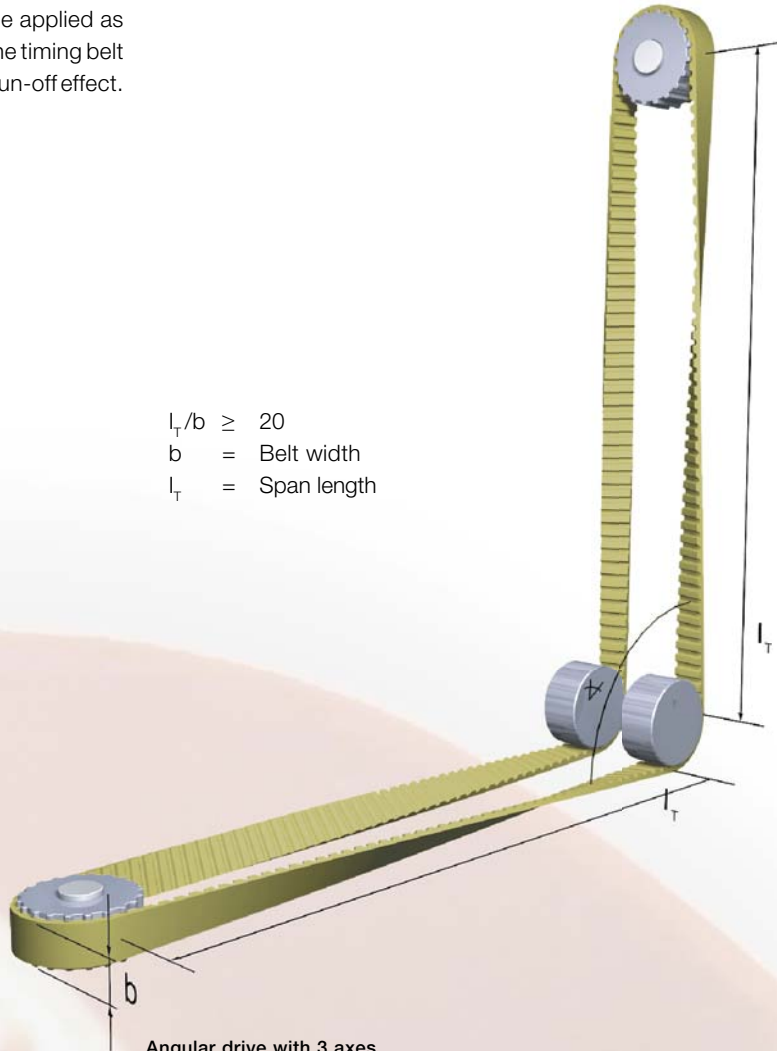

Angular drive with 3 axes

With crossed timing belt applications the outer tension members suffer a higher elongation than the inner ones. Due to the larger elongation in the edge zone the permitted proportional circumferential force for the belt in the tension members is reduced.

No power reductions or special measures are necessary at a ratio of  $l_T / b \geq 20$ .

At a required ratio of  $l_T / b < 20$  please contact our technical department for advice.

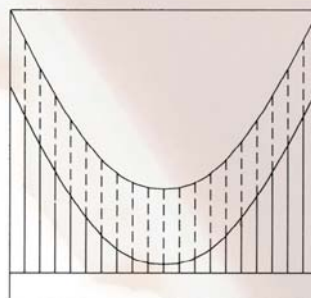

$F_{zul}$  admissible tensile force

$F_U$  The remaining peripheral force

$F_S$  Tensile force due to crossing

# Guiding belts with flanges

Timing belts must be guided to eliminate the lateral run-off effect. This is normally done by flanges. Minimum lateral forces and low frictional losses can be resulted by the optimum arrangement of the belt guidance.

**For this purpose, the following possibilities are available:**

- Timing belt guidance downstream of a large free span length (infeed length (a) should not be less than 5 times belt width)
- Guidance at the drive pulley (preferable for two shaft drives with short centre distance)
- Guide for low-transmission pulleys (preferably for multiple-shaft drives)
- Guidance on the tension rollers
  - Tension roller arrangement in the slack span side
  - With arrangement on the belt back side: consider minimum diameter with contraflexure
  - With arrangement on the belt toothed side: Length of arc of contact, min. 3 teeth
  - with changing rotational directions preferable in the span length centre
  - Condition: Minimum span length (a) between tension roller and pulley should not be less than 5 times belt width
- Ensure high axis parallelity and flush alignment of all pulleys to achieve optimum guiding features.
- For cost reasons it is possible to fit flanges also to the smaller pulley after taking the functional reliability into consideration.

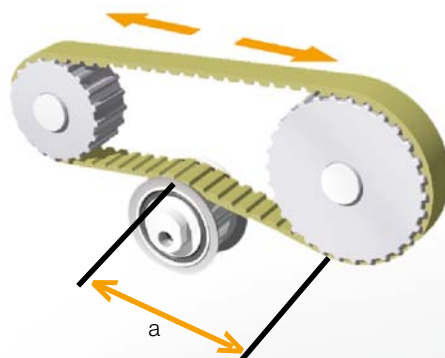

The application of CONTI® SYNCHROFLEX polyurethane timing belts in two-filament arrangement is the ideal prerequisite for an optimum belt guidance.

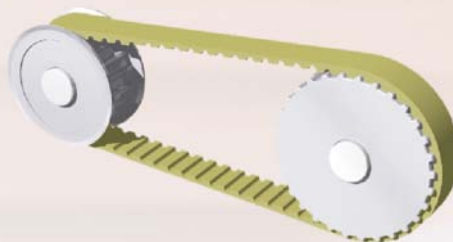

# Tooth gap shapes

Timing belts are positive fitted drive elements. They work slippage-free with the respective synchronising pulleys. CONTI® SYNCHROFLEX timing belt drives can be optimised additionally for a movement transmission with a low flank backlash.

For some profiles and pitches, the SE or zero gap can be used for especially high accuracy drives. Please contact us for technical advice.

- Prerequisites for the application:
  - Pitch matching between timing belts and pulley.
- Influencing factors of the pitch matching:
  - Pre-tension force
  - No. of teeth in mesh ( $z_g$ )
  - Load rate (rotational speed, dynamic behaviour...)
  - Manufacturing tolerances

## Tooth gap shapes

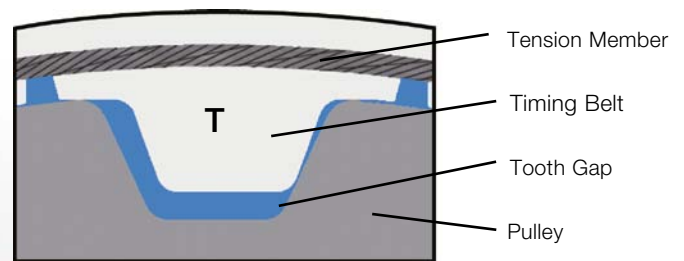

Normal Backlash  
Tooth Gap

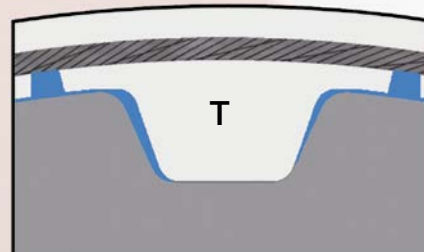

Reduced Backlash  
"SE" Tooth Gap

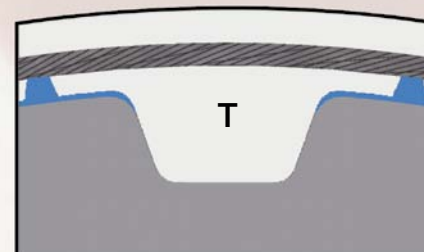

Zero Backlash  
"0" Tooth Gap

# Safety factors

The width of a timing belt is correct when the permissible values for tooth shear strength, tension cord strength and flexibility are not exceeded under unfavourable operating conditions. In our catalogue, load limits are stated which have been reliably proven and confirmed by bench tests and results obtained in practice. A safety factor is only required for drives with transmission into higher speed.

It is important, that the unfavourable load types occurring in the drive are known resp. correctly estimated by the engineer. With a positive fit transmission, even short-period overloads act via the timing belt being the drive member. Some instructions to this issue:

## Rated operation

Design timing belts for the operating condition of the rated load. The rated load is the operating condition at which the drive should transmit the torque or the power at rated speeds under normal conditions.

## Start-up characteristics

a) Drive side: The max. torque of the drive machine under start-up conditions is to be taken into consideration. The start-up torque, e.g. for three-phase squirrel cage motors amounts to 2 to 2.5 times the rated value.

b) On the drive side: If necessary, „initial torques“ affective to the drive part timing belt are to be taken into consideration under start-up characteristics.

Check load case a) or b) with rotational speed  $n=0$ .

## Braking

It might have to be defined whether braking leads to loads which fully act via the timing belt and possibly exceed the type of load produced by the rated operation or the start-up characteristics. During braking a possible torque reversal should be taken into consideration.

## Unevennesses (load variations, shock loads)

In addition to the rated load, superimposed vibration and shock loads could act on the timing belt as the transmission member. For the illustrated example, increase the calculated belt width by the factor of 1.3.

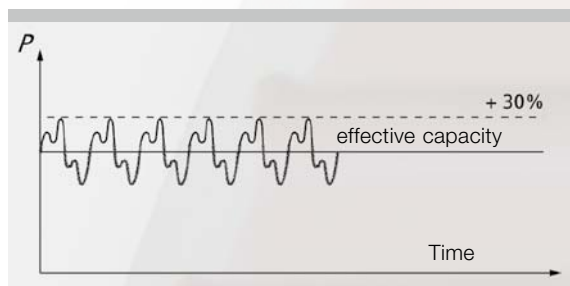

## Moments of inertia

Moments of inertia and/or centrifugal masses in the drives generally create a uniform running behaviour. Depending on the acceleration and deceleration characteristic it has to be differentiated and checked whether the moments of inertia create an additional load on the timing belt.

## Step-up transmission

The following safety factors are to be applied for step-up transmissions:

$i = 0,66$ up to $1,00$	$S = 1,1$
$i = 0,40$ up to $0,66$	$S = 1,2$
$i < 0,40$	$S = 1,3$

During braking a torque reversal may occur which would change a reduction ration into a step-up drive.



# Pre-tension force

## Pre-tension force

Pre-tension is intended to guarantee a minimum tensioning force at the slack span side to ensure smooth tooth meshing into the driven pulley.

Generally, the pre-tension should only be set as high as necessary. The necessary pre-tension force of the spans  $F_V$  depends on the max. peripheral force  $F_U$ , the belt length  $L_B$  (number of teeth  $Z_B$ ) and the drive configuration.

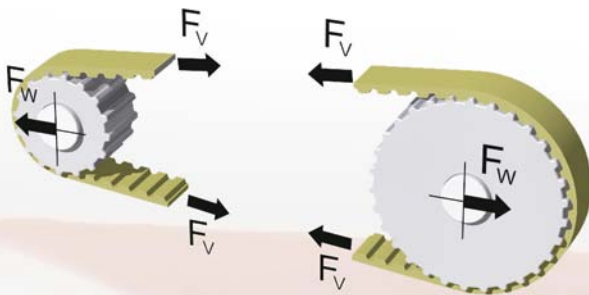

The recommendations shown in the table refer to the pre-tension force setting per span.

Drive configuration	Pre-tension force of each individual span
Two-shaft drive	
$Z_B < 60$	$F_V = 1/3 F_U$
$60 \leq Z_B < 150$	$F_V = 1/2 F_U$
$Z_B > 150$	$F_V = 2/3 F_U$
Multiple-shaft drive	
$l_{\text{Load span}} \leq l_{\text{Slack span}}$	$F_V = F_U$
$l_{\text{Load span}} > l_{\text{Slack span}}$	$F_V > F_U$
Linear drive	$F_V \geq F_U$

In every case, the tension cord strength is the top limit of the span load. Take into consideration that especially with multiple-shaft and linear drives, an addition of the pre-tension force and the peripheral force in relation to the load span force is to be expected.

## Influencing factors

### Belt stiffness

Friction forces created by the interaction of the tooth mesh (especially at the slack span) intensify the span forces, which in turn increase the degree of elongation. This influence may lead to the slack span tooth mesh butting against the driven pulley, thereby causing the belt to jump.

Elongation being directly depending on the belt stiffness, the high stiffness of the steel cord tension members permits a comparably low pre-tension.

### Peripheral force

The peripheral force acts in proportion to the elongation of the load span, i.e. excessive slackening of the slack span can be counter-acted by a pre-tension matched to the peripheral force.

### Belt length

Belt elongation resulting from the effect of the peripheral force and the friction forces is also approximately in proportion to the belt length. Therefore, the tendency of running up or jumping is considerably influenced by the belt length. Even under high peripheral forces with the resulting friction forces, a very short timing belt will elongate to only a small degree, so that even when subject to low pre-tension forces there will be no danger of running up or jumping of teeth. On the contrary, with short timing belts peripheral deviations of the pulleys could cause heavy pre-tension fluctuations and, as a result, extreme peak values.

### Proportion of the span lengths

Especially with multiple-shaft drives the load span is often markedly longer than the slack span side. For this reason, a slight elongation of the load span results in a very unfavourable slack on the span side. Therefore, the pre-tension force of spans of such ratios should be higher than the peripheral force.

### Precise transmission of movement

There is a high transmission accuracy possible in the reverse operation with CONTI® SYNCHROFLEX Timing Belts, when the span pre-tension forces are selected in the same size of the peripheral force.

# Pre-tension force

## Consequences of faulty pre-tension setting:

### too low pre-tension

- the teeth of the slack span side run up on or override the teeth of the driven pulley
- Wear on the faces caused by the friction force during meshing
- Forced breakage by excessive elongation due to full overriding

### excessive pre-tension

- high bearing load of the shafts
- Reduction of the transmittable power
- Wear and tear at the belt tooth

## Measuring with frequency measuring meter

The intrinsic frequency of a vibrating belt span can be measured by means of various Mulco belt tension measuring meters. The pre-tension force of the span can be calculated from the measured intrinsic frequency:

$$F_V = 4 \cdot m \cdot l_T^2 \cdot f^2$$

The corresponding intrinsic frequency can be calculated, if the pre-tension is preset:

$$f = \sqrt{\frac{F_V}{4 \cdot m \cdot l_T^2}}$$

- f: Frequency of the variations in Hz  
 m: Mass of the belt per meter length in kg/m  
 l<sub>T</sub>: drum span length subject to vibration in m  
 F<sub>V</sub>: Span force in N

Please contact your Mulco partner for the various measuring meters (see page 16).

## General informations

### Design

- In the transmission configuration, design at least one adjustable axis, plan one adjustable tension roller (not spring-loaded) for fix centre distances
- the bearing has to be absolutely rigid
- Note the importance of a parallel run and flush alignment of the timing pulleys

### Transport/storing

- Upon receipt, unpack the timing belt immediately and store in circular position (CONTI® SYNCHROFLEX Timing Belts) in a dry place at room temperature
- Do not bend

### Mounting

- Fit timing belts on the pulleys when slack without exerting any force
- Exert no force when fitting with fixed centre distances (CONTI® SYNCHROFLEX Timing Belts) if necessary, fit together with timing pulleys
- Apply pre-tensioning force according to the chapter „Pre-tension“
- secure adjustable axis against slippage
- Do not clamp the timing belt between the flanges

### Operation

- Protect the drives against dust, dirt, hot surrounding media as well as acids and alkalis
- Take into consideration the ambient temperatures (see Characteristics of polyurethane timing belts)

# Basis of calculation

Providing the following conditions of tooth strength (1st), tension member tensile strength (2nd) and flexibility (3rd)

are met, then a maintenance-free timing belt operation can be expected.

## 1. Tooth shear strength

### specific tooth shear strength

Force distribution

Load distribution

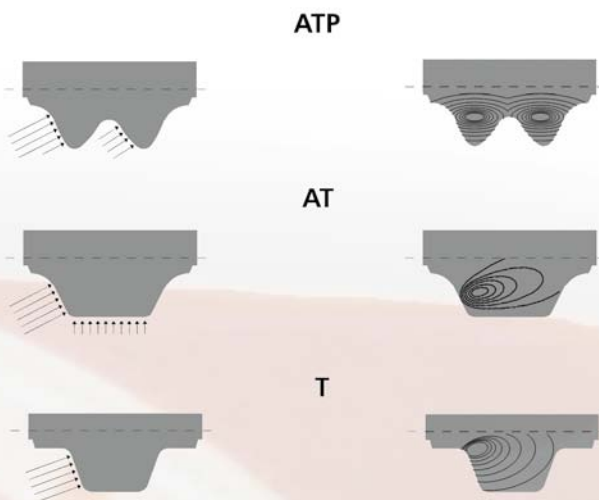

The specific tooth shear strength depends on the rotational speed. The maximum specific tooth shear strength is the limit load the belt tooth can bear in continuous operation. The values are stated in tables for each timing belt type. The timing belt drive is correctly designed, when not exceeding the admissible tooth shear strength. Generally, a special safety factor is not necessary, see chapter „Safety factors“.

The high specific tooth shear strength of the ATP profile, for example, is achieved by the optimised force and load distribution. The effective force is distributed to two tooth faces.

The working loads can be distributed more effectively with more belt teeth meshing in the pulley.

Due to the high pitch accuracy of CONTI® SYNCHROFLEX Timing Belts, generally, it can be calculated with 12 belt teeth in mesh, unless there are less than that number actually in mesh.

## 2. Tension member strength

Admissible tensile stress on the belt's cross-section

The timing belt is designed correctly, when the maximum admissible tensile force in the steel cord tension members is not exceeded under operation conditions. The table values for  $F_{zul}$  refer to the constant loading.

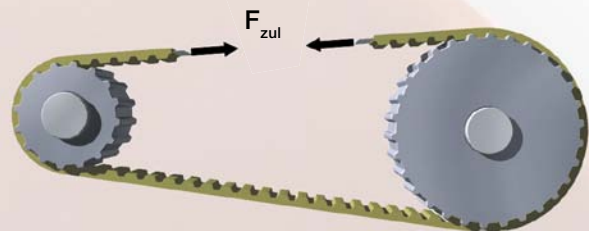

## 3. Flexibility

Minimum number of teeth, minimum diameter

The recommended minimum number of teeth and/or the minimum diameter for a malfunction-free operation depends on the selected belt type. Take especially into consideration that the minimum number of teeth and/or the minimum diameter is higher when using a belt arrangement „with contraflexure“ (e. g. due to a tension roller).

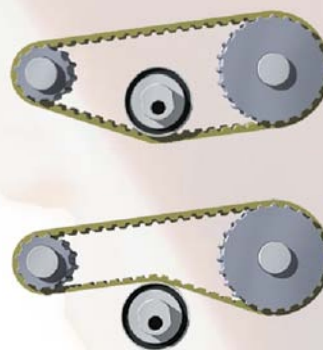

Drive layout without contraflexure

Drive layout with contraflexure

# Calculation example

## Calculation example Terms, definitions

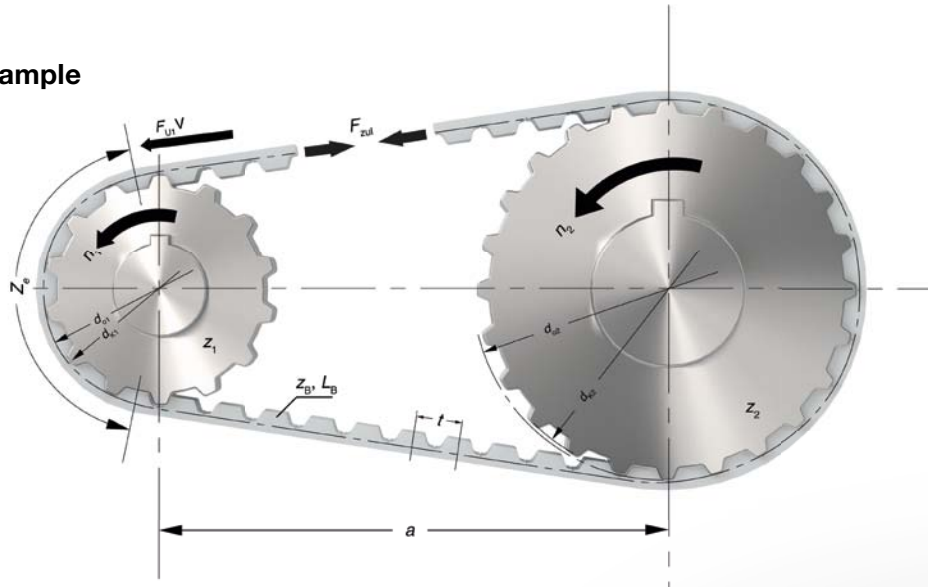

Peripheral force	$F_U$	[N]
specific tooth force	$F_{U, spec}$	[N/cm]
admissible tensile force	$F_{zul}$	[N]
Pre-tension force	$F_V$	[N]
Shaft force	$F_w$	[N]
Torque	$M$	[Nm]
Acceleration torque	$M_B$	[Nm]
specific torque	$M_{spec}$	[Ncm/cm]
Power	$P$	[kW]
specific power	$P_{spec}$	[W/cm]
Load bearing torque	$J$	[kgm <sup>2</sup> ]
Load	$m$	[kg]
Density	$\rho$	[kg/dm <sup>3</sup> ]
Speed	$v$	[m/s]
Rotational speed	$n$	[min <sup>-1</sup> ]
Angular speed	$\omega$	[s <sup>-1</sup> ]
Frequency	$f_e$	[s <sup>-1</sup> ]

Centre distance	$a$	[mm]
Belt length	$L_B$	[mm]
Belt width	$b$	[mm]
Pulley width	$B$	[mm]
Bore, pulley	$d$	[mm]
Pitch circle diameter	$d_o$	[mm]
Outside diameter	$d_k$	[mm]
Span length	$L_T$	[mm]
Pitch	$t$	[mm]
Number of belt teeth	$Z_B$	
Number of teeth with $i = 1$	$z$	
Number of teeth in mesh	$Z_e$	
No. of teeth, small pulley	$Z_1$	
No. of teeth, large pulley	$Z_2$	
Ratio	$i$	
Acceleration time	$t_B$	[s]

### Peripheral force

$$F_U = \frac{2 \cdot 10^3 \cdot M}{d_o}$$

$$= \frac{19,1 \cdot 10^6 \cdot P}{n \cdot d_o}$$

$$= \frac{10^3 \cdot P}{v}$$

### Torque

$$M = \frac{d_o \cdot F_U}{2 \cdot 10^3}$$

$$= \frac{9,55 \cdot 10^3 \cdot P}{n}$$

$$= \frac{d_o \cdot P}{2 \cdot v}$$

### Power

$$P = \frac{M \cdot n}{9,55 \cdot 10^3}$$

$$= \frac{F_U \cdot d_o \cdot n}{19,1 \cdot 10^6}$$

$$= \frac{F_U \cdot v}{10^3}$$

### Belt Length for $i = 1$

$$L_B = 2a + \pi \cdot d_o$$

$$= 2a + z \cdot t$$

### Angular speed

$$\omega = \frac{\pi \cdot n}{30}$$

### Rotational speed

$$n = \frac{19,1 \cdot 10^3 \cdot v}{d_o}$$

### Speed

$$v = \frac{d_o \cdot n}{19,1 \cdot 10^3}$$

### Pitch circle diameter

$$d_o = \frac{z \cdot t}{\pi}$$

### Acceleration torque

$$M_B = \frac{J \cdot \Delta n}{9,55 \cdot t_B}$$

### Load bearing torque

$$J = 98,2 \cdot 10^{-15} \cdot B \cdot \rho \cdot (d_k^4 - d^4)$$

Apply all equations with the dimensions mentioned here.

## Calculation example

**Task** A roll table drive must be designed for heavy conveying duties. Under start-up conditions approx. 2.5 times the running torque is exerted on the timing belt.

**The application conditions are:**

<b>Given:</b>	Power	$P = 10$	kW
	Nominal speed	$n = 800$	$\text{min}^{-1}$
	Start-up torque	$M = 300$	Nm
	Ratio	$i = 1$	
	Number of teeth	$z = 25$	
	Centre distance	$a = 625$	mm

**Required:** The timing belt pitch is to be determined and the belt width is to be calculated.

**Formulae:**

$$b = \frac{100 \cdot M}{z_1 \cdot z_e \cdot M_{\text{spec}}} \quad M[\text{Nm}]$$

$$b = \frac{1000 \cdot P}{z_1 \cdot z_e \cdot P_{\text{spec}}} \quad P[\text{kW}]$$

$$F_u = \frac{2 \cdot 10^3 \cdot M}{d_o} \quad F_u [\text{N}]$$

$$L = 2 \cdot a + z \cdot t \quad [\text{mm}]$$

$$d_o = \frac{z \cdot t}{\pi} \quad [\text{mm}]$$



# Calculation example

## How to proceed

**Belt length:** Profile preselection: AT10. Calculation of the belt length with formula:

$$\begin{aligned} L &= 2 \cdot a + z \cdot t \\ &= 2 \cdot 625 + 25 \cdot 10 \\ &= \underline{1500 \text{ mm}} \end{aligned}$$

**Calculation of the belt width:**

### 1. Tooth shear strength

In the calculation  $z_e = 12$  will be used (see basis of calculation).

Calculation of the belt width with the nominal speed from the power equations.

$$\begin{aligned} b &= \frac{1000 \cdot P}{z_1 \cdot z_e \cdot P_{\text{spec}}} \\ &= \frac{1000 \cdot 10}{25 \cdot 12 \cdot 6,96} \\ &= 4,79 \text{ cm} = \underline{47,9 \text{ mm}} \end{aligned}$$

Calculation of the belt width under start-up torque when rotational speed  $n = 0$ .

$$\begin{aligned} b &= \frac{100 \cdot M}{z_1 \cdot z_e \cdot M_{\text{spec}}} \\ &= \frac{100 \cdot 300}{25 \cdot 12 \cdot 11,70} \\ &= 8,54 \text{ cm} = \underline{85,4 \text{ mm}} \end{aligned}$$

The belt width is to be determined from the least favourable load conditions.

Selected: the next larger standard belt width  $b = \underline{100 \text{ mm}}$ .

### 2. Tension member strength

The corresponding peripheral force can be calculated from the general data supplied:

$$\begin{aligned} F_U &= \frac{2 \cdot 10^3 \cdot M}{d_0} \\ &= \frac{2 \cdot 10^3 \cdot M}{79,58} = \underline{7539 \text{ N} < 16000 \text{ N}} \end{aligned}$$

The tabular value  $F_{zul}$  for AT 10 with 100 mm belt width is 16000 N. Thus, there is a sufficient tension member safety factor.

### 3. Flexibility

The design is a drive „without contraflexure“. The minimum number of teeth according to the table is adhered to.

**Result:** The drive is correctly designed with a belt width of 100 mm. A maintenance-free operation can be expected.

Order code: CONTI® SYNCHROFLEX 100 AT 10/1500

## CONTI® SYNCHROFLEX Timing Belts used for transportation

Transport belts should be designed preferably with a head drive. The goods to be transported can consist of one or more individual loads. Multiple individual loads can be seen as a line load.

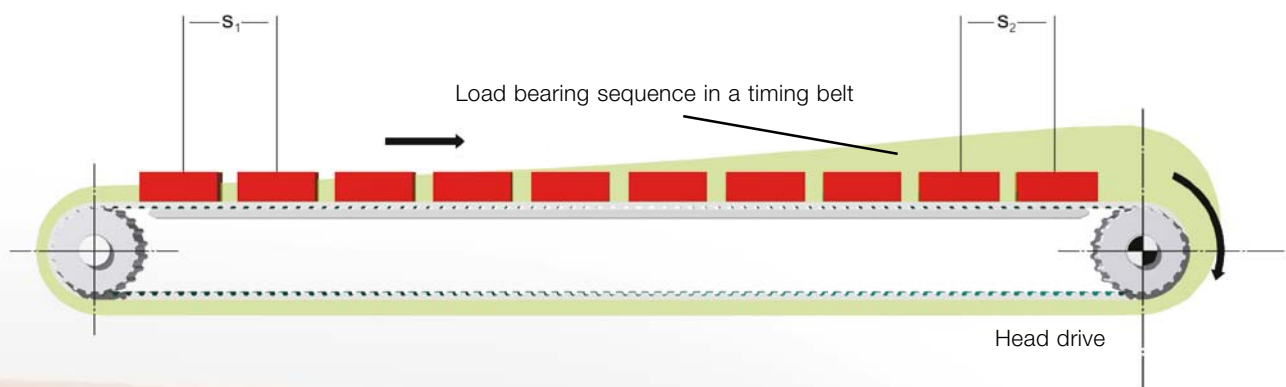

### Calculation of the Peripheral force $F_U$

From the overall transport load, the required haul-off force or the peripheral force  $F_U$  for the drive pulley assemblies can be derived:

$$F_U = 9,81 \cdot m \cdot \mu$$

Peripheral force at the drive pulley.	$F_U$	[N]
Mass of the items to be transported	$m$	[kg]
Friction factor of the timing belt in relation to the bed plate	$\mu$	

As friction factor  $\mu$  (slide friction), the following values can be assumed:

Steel/PUR 92 Shore A	0,6 - 0,7
PE/PUR	0,3 - 0,4

In general, friction factors show large ranges. Trials should be carried out, if necessary. Errors and omissions excepted.

### Information on the force/elongation behaviour

The grid surface in the picture shows the force/elongation behaviour in the timing belt under operating conditions. The individual spacing between the transported products increases towards the drive pulley due to belt elongation.

Centre  $s_1 < s_2$

### Pre-tension force

We recommend to set the pre-tension force in the transport timing belt such that a residual pre-tension force is always maintained on the slack span side under operating conditions. The following pre-tension force is required::

$$F_V > 0,5 \cdot F_U$$

### Calculating the Belt width $b$

$$b = \frac{F_U}{z_e \cdot F_{U\text{spec}}} \quad F_U [\text{N}]$$

$F_U$ : peripheral force (calculated)

$F_{U\text{spec}}$ : specific load of the belt teeth

$z_e$ : number of teeth in mesh for endless joined belts:  
 $z_{\text{emax}} = 12$

# AT high performance Timing Belts

## AT 3 GEN III

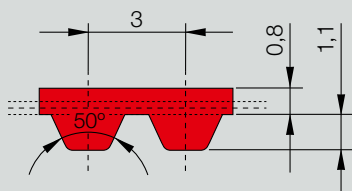

CONTI® SYNCHROFLEX Timing Belt (SFX) AT 3 GEN III

High performance AT profile with metric pitch and trapezoidal teeth.

**Standard version:**

- single-sided
- high performance polyurethane in red colour
- steel cord tension members with high density
- steel cord tension members in two-filament construction
- steel cord tension members in highly flexible construction

**FA:** with bigger back thickness

**FN:** with profiles on the back of the belt

Type / Length* GEN III	Number of teeth	Type / Length* GEN III	Number of teeth
AT 3 / 150	50	AT 3 / 816	272
AT 3 / 201	67	AT 3 / 816 FA	272
AT 3 / 201 FN68	67	AT 3 / 900	300
AT 3 / 252	84	AT 3 / 1011	337
AT 3 / 267	89		
AT 3 / 270	90		
AT 3 / 300	100		
AT 3 / 351	117		
AT 3 / 399	133		
AT 3 / 417	139		
AT 3 / 450	150		
AT 3 / 486 FN18	162		
AT 3 / 501	167		
AT 3 / 549	183		
AT 3 / 600	200		
AT 3 / 639	213		
AT 3 / 648	216		
AT 3 / 648 FN24	216		
AT 3 / 714	238		

Preferred belt width\* in mm:  
6, 10, 16, 25, 32

\* Other dimensions upon request.

**Order example**

CONTI® SYNCHROFLEX Timing Belt 10 AT3/450 GEN III

Belt width in mm \_\_\_\_\_

Type/Pitch \_\_\_\_\_

Belt length in mm \_\_\_\_\_

Specification Generation III \_\_\_\_\_

# AT 3 GEN III Technical data

## 1. Tooth shear strength (specific belt tooth strength)



R.p.m. n [min <sup>-1</sup> ]	F <sub>Uspec</sub> [N/cm]	M <sub>spec</sub> [Ncm/cm]	P <sub>spec</sub> [W/cm]	R.p.m. n [min <sup>-1</sup> ]	F <sub>Uspec</sub> [N/cm]	M <sub>spec</sub> [Ncm/cm]	P <sub>spec</sub> [W/cm]
0	40,43	1,93	0,00	2400	24,66	1,18	2,96
20	40,00	1,91	0,04	2500	24,40	1,17	3,05
40	39,60	1,89	0,08	2600	24,14	1,15	3,14
60	39,21	1,87	0,12	2800	23,63	1,13	3,31
80	38,85	1,86	0,16	3000	23,16	1,11	3,47
100	38,50	1,84	0,19	3200	22,71	1,09	3,63
150	37,70	1,80	0,28	3400	22,30	1,07	3,79
200	36,98	1,77	0,37	3600	21,90	1,05	3,94
300	35,69	1,70	0,54	3800	21,53	1,03	4,09
400	34,60	1,65	0,69	4000	21,16	1,01	4,23
500	33,64	1,61	0,84	4500	20,34	0,97	4,58
600	32,79	1,57	0,98	5000	19,59	0,94	4,90
700	32,03	1,53	1,12	5500	18,90	0,90	5,20
800	31,34	1,50	1,25	6000	18,28	0,87	5,48
900	30,70	1,47	1,38	6500	17,69	0,85	5,75
1000	30,11	1,44	1,51	7000	17,15	0,82	6,00
1100	29,56	1,41	1,63	7500	16,65	0,80	6,24
1200	29,05	1,39	1,74	8000	16,18	0,77	6,47
1300	28,58	1,36	1,86	8500	15,74	0,75	6,69
1400	28,13	1,34	1,97	9000	15,31	0,73	6,89
1500	27,70	1,32	2,08	9500	14,91	0,71	7,08
1600	27,30	1,30	2,18	10000	14,54	0,69	7,27
1700	26,91	1,29	2,29	12000	13,19	0,63	7,91
1800	26,55	1,27	2,39	15000	11,53	0,55	8,64
1900	26,20	1,25	2,49	18000	10,16	0,49	9,15
2000	25,88	1,24	2,59	20000	9,38	0,45	9,37
2200	25,25	1,21	2,78				

Rotational speeds over 20000 rpm and/or belt speeds over 80 m/s need special drive designs. Please ask our advice.

## 2. Tension member strength (permitted tensile force of the belt F<sub>zul</sub>), Belt weight

Belt width	b	[mm]	6	10	16	25	32
Tension member strength F <sub>zul</sub>		[N]	330	599	1002	1608	2079
Belt weight	AT 3 GEN III	[kg/m]	0,016	0,026	0,042	0,065	0,083

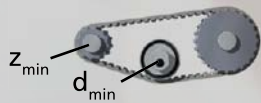
## 3. Flexibility (Minimum numbers of teeth, minimum diameter)

Timing pulley	z <sub>min</sub>	15		Drive type without contraflexure
Tension roller (smooth), running on teeth	d <sub>min</sub> [mm]	20		
Timing pulley	z <sub>min</sub>	20		Drive type with contraflexure
Tension roller (smooth), running on the back of the belt	d <sub>min</sub> [mm]	20		

# AT high performance Timing Belts

## AT 3

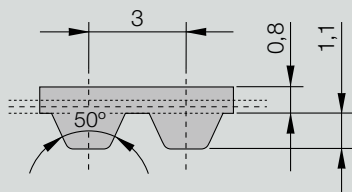

### CONTI® SYNCHROFLEX Timing Belt (SFX) AT 3

High performance AT profile with metric pitch and trapezoidal teeth.

The technical data refer to standard polyurethane and standard steel cord tension members.

#### Available versions:

- single-sided
- with reinforced design
- with Aramide tension member
- polyurethane special materials upon request
- antistatic, coloured, mechanical reworked

**FA:** with bigger back thickness

**FN:** with profiles on the back of the belt

Type / Length*	Number of teeth	Type / Length*	Number of teeth
AT 3 / 150	50	AT 3 / 816	272
AT 3 / 201	67	AT 3 / 816 FA	272
AT 3 / 201 FN68	67	AT 3 / 900	300
AT 3 / 252	84	AT 3 / 1011	337
AT 3 / 267	89		
AT 3 / 270	90		
AT 3 / 300	100		
AT 3 / 351	117		
AT 3 / 399	133		
AT 3 / 417	139		
AT 3 / 450	150		
AT 3 / 486 FN18	162		
AT 3 / 501	167		
AT 3 / 549	183		
AT 3 / 600	200		
AT 3 / 639	213		
AT 3 / 648	216		
AT 3 / 648 FN24	216		
AT 3 / 714	238		

Preferred belt width\* in mm:  
6, 10, 16, 25, 32

\* Other dimensions upon request.

#### Order example

CONTI® SYNCHROFLEX Timing Belt 10 AT3 / 450

Belt width in mm \_\_\_\_\_

Type/Pitch \_\_\_\_\_

Belt length in mm \_\_\_\_\_



## AT 3 Technical data

### 1. Tooth shear strength (specific belt tooth strength)

R.p.m. n [min <sup>-1</sup> ]	F <sub>Uspec</sub> [N/cm]	M <sub>spec</sub> [Ncm/cm]	P <sub>spec</sub> [W/cm]	R.p.m. n [min <sup>-1</sup> ]	F <sub>Uspec</sub> [N/cm]	M <sub>spec</sub> [Ncm/cm]	P <sub>spec</sub> [W/cm]
0	32,34	1,544	0,000	2200	20,20	0,964	2,222
20	32,00	1,528	0,032	2400	19,73	0,942	2,367
40	31,68	1,513	0,063	2500	19,52	0,932	2,440
60	31,37	1,498	0,094	2600	19,31	0,922	2,510
80	31,08	1,484	0,124	2800	18,90	0,902	2,646
100	30,80	1,471	0,154	2880	18,75	0,895	2,700
150	30,16	1,440	0,226	3000	18,53	0,885	2,779
200	29,58	1,412	0,296	3200	18,17	0,868	2,907
300	28,55	1,363	0,428	3400	17,84	0,852	3,033
400	27,68	1,322	0,554	3600	17,52	0,837	3,153
500	26,91	1,285	0,673	3800	17,22	0,822	3,272
600	26,23	1,252	0,787	4000	16,93	0,808	3,386
700	25,62	1,223	0,897	4500	16,27	0,777	3,660
730	25,45	1,215	0,929	5000	15,67	0,748	3,917
800	25,07	1,197	1,003	5500	15,12	0,722	4,158
900	24,56	1,173	1,105	6000	14,62	0,698	4,386
1000	24,09	1,150	1,204	6500	14,15	0,676	4,598
1100	23,65	1,129	1,301	7000	13,72	0,655	4,802
1200	23,24	1,110	1,394	7500	13,32	0,636	4,995
1300	22,86	1,091	1,486	8000	12,94	0,618	5,176
1400	22,50	1,074	1,575	8500	12,59	0,601	5,350
1460	22,29	1,064	1,627	9000	12,25	0,585	5,512
1500	22,16	1,058	1,662	9500	11,93	0,570	5,666
1600	21,84	1,043	1,747	10000	11,63	0,555	5,815
1700	21,53	1,028	1,830	12000	10,55	0,504	6,330
1800	21,24	1,014	1,911	15000	9,22	0,440	6,914
1900	20,96	1,001	1,991	18000	8,13	0,388	7,316
2000	20,70	0,988	2,070	20000	7,50	0,358	7,499

Rotational speeds over 20000 rpm and/or belt speeds over 80 m/s need special drive designs. Please ask our advice.

### 2. Tension member strength (permitted tensile force of the belt F<sub>zul</sub>), Belt weight

Belt width	b	[mm]	6	10	16	25	32
Tension member strength F <sub>zul</sub>		[N]	190	380	646	1102	1406
Belt weight	AT 3	[kg/m]	0,014	0,023	0,037	0,058	0,074

### 3. Flexibility (Minimum numbers of teeth, minimum diameter)

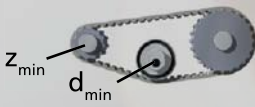
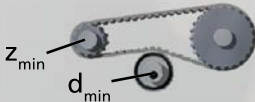
Timing pulley	z <sub>min</sub>	15		Drive type without contraflexure
Tension roller (smooth), running on teeth	d <sub>min</sub> [mm]	20		
Timing pulley	z <sub>min</sub>	20		Drive type with contraflexure
Tension roller (smooth), running on the back of the belt	d <sub>min</sub> [mm]	20		

# AT high performance Timing Belts

## AT 5 GEN III

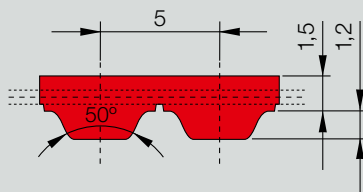

CONTI® SYNCHROFLEX Timing Belt (SFX) AT 5 GEN III

High performance AT profile with metric pitch and trapezoidal teeth.

**Standard version:**

- single-sided
- high performance polyurethane in red colour
- steel cord tension members with high density
- steel cord tension members in two-filament construction
- steel cord tension members in highly flexible construction

**FA:** with bigger back thickness

Type / Length* GEN III	Number of teeth	Type / Length* GEN III	Number of teeth
AT 5 / 225	45	AT 5 / 720	144
AT 5 / 255	51	AT 5 / 750	150
AT 5 / 260	52	AT 5 / 780	156
AT 5 / 280	56	AT 5 / 825	165
AT 5 / 300	60	AT 5 / 860	172
AT 5 / 330	66	AT 5 / 875	175
AT 5 / 340	68	AT 5 / 900	180
AT 5 / 375	75	AT 5 / 920	184
AT 5 / 390	78	AT 5 / 975	195
AT 5 / 420	84	AT 5 / 1050	210
AT 5 / 450	90	AT 5 / 1125	225
AT 5 / 455	91	AT 5 / 1230	246
AT 5 / 480	96	AT 5 / 1500	300
AT 5 / 490	98	AT 5 / 1750	350
AT 5 / 500	100	AT 5 / 2000	400
AT 5 / 525	105	AT 5 / 3350 FA**	670
AT 5 / 545	109	AT 5 / 3800 FA**	760
AT 5 / 600	120		
AT 5 / 610	122		
AT 5 / 620	124		
AT 5 / 630	126		
AT 5 / 660	132		
AT 5 / 670	134		
AT 5 / 690	138		
AT 5 / 710	142		

Preferred belt width\* in mm:  
6, 10, 16, 25, 32, 50, 75, 100

\* Other dimensions upon request.  
\*\* Please request technical support from your Mulco sales partner.

**Order example**

CONTI® SYNCHROFLEX Timing Belt 50 AT5 / 450 GEN III

Belt width in mm \_\_\_\_\_

Type/Pitch \_\_\_\_\_

Belt length in mm \_\_\_\_\_

Specification Generation III \_\_\_\_\_

# AT 5 GEN III Technical data

## 1. Tooth shear strength (specific belt tooth strength)



R.p.m. n [min <sup>-1</sup> ]	F <sub>Uspec</sub> [N/cm]	M <sub>spec</sub> [Ncm/cm]	P <sub>spec</sub> [W/cm]	R.p.m. n [min <sup>-1</sup> ]	F <sub>Uspec</sub> [N/cm]	M <sub>spec</sub> [Ncm/cm]	P <sub>spec</sub> [W/cm]
0	44,13	3,51	0,00	2000	27,38	2,18	4,56
20	43,63	3,48	0,07	2200	26,63	2,12	4,89
40	43,13	3,44	0,14	2400	26,00	2,07	5,20
60	42,63	3,40	0,21	2600	25,38	2,02	5,50
80	42,25	3,36	0,28	2800	24,80	1,97	5,79
100	41,88	3,33	0,35	3000	24,28	1,93	6,06
200	40,00	3,19	0,67	3200	23,76	1,89	6,34
300	38,63	3,08	0,96	3400	23,30	1,85	6,60
400	37,25	2,96	1,24	3600	22,85	1,82	6,85
500	36,25	2,88	1,51	3800	22,41	1,78	7,10
600	35,25	2,80	1,76	4000	22,01	1,85	7,34
700	34,28	2,74	2,00	4500	21,08	1,68	7,90
800	33,50	2,68	2,24	5000	20,23	1,61	8,43
900	32,88	2,61	2,46	5500	19,45	1,55	8,91
1000	32,13	2,56	2,68	6000	18,75	1,49	9,38
1100	31,50	2,51	2,89	6500	18,10	1,44	9,80
1200	31,00	2,64	3,10	7000	17,49	1,39	10,20
1300	30,38	2,42	3,30	7500	16,93	1,35	10,58
1400	29,88	2,38	3,49	8000	16,39	1,30	10,93
1500	29,38	2,34	3,68	8500	15,89	1,26	11,25
1600	29,00	2,30	3,86	9000	15,41	1,23	11,55
1700	28,50	2,27	4,04	9500	14,96	1,19	11,84
1800	28,13	2,24	4,21	10000	14,54	1,16	12,11
1900	27,75	2,21	4,39				

Rotational speeds over 10000 rpm and/or belt speeds over 80 m/s need special drive designs. Please ask our advice.

## 2. Tension member strength (permitted tensile force of the belt F<sub>zul</sub>), Belt weight

Belt width b [mm]		6	10	16	25	32	50	75	100
Tension member strength F <sub>zul</sub> [N]		417	787	1342	2175	2823	4489	6803	9117
Belt weight AT 5 GEN III [kg/m]		0,022	0,036	0,058	0,090	0,115	0,180	0,270	0,360

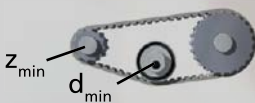
## 3. Flexibility (Minimum numbers of teeth, minimum diameter)

Timing pulley	z <sub>min</sub>	15		Drive type without contraflexure
Tension roller (smooth), running on teeth	d <sub>min</sub> [mm]	25		
Timing pulley	z <sub>min</sub>	20		Drive type with contraflexure
Tension roller (smooth), running on the back of the belt	d <sub>min</sub> [mm]	60		

# AT high performance Timing Belts

## AT 5

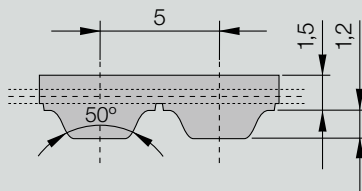

CONTI® SYNCHROFLEX Timing Belt (SFX) AT 5

High performance AT profile with metric pitch and trapezoidal teeth.

The technical data refer to standard polyurethane and standard steel cord tension members.

**Available versions:**

- single-sided
- with "E" tension member for a better flexibility
- with reinforced design
- with Aramide tension member
- polyurethane special materials upon request
- antistatic, coloured, mechanical reworked

Type / Length*	Number of teeth	Type / Length*	Number of teeth
AT 5 / 225	45	AT 5 / 720	144
AT 5 / 255	51	AT 5 / 750	150
AT 5 / 260	52	AT 5 / 780	156
AT 5 / 280	56	AT 5 / 825	165
AT 5 / 300	60	AT 5 / 860	172
AT 5 / 330	66	AT 5 / 875	175
AT 5 / 340	68	AT 5 / 900	180
AT 5 / 375	75	AT 5 / 920	184
AT 5 / 390	78	AT 5 / 975	195
AT 5 / 420	84	AT 5 / 1050	210
AT 5 / 450	90	AT 5 / 1125	225
AT 5 / 455	91	AT 5 / 1230	246
AT 5 / 480	96	AT 5 / 1500	300
AT 5 / 490	98	AT 5 / 1750	350
AT 5 / 500	100	AT 5 / 2000	400
AT 5 / 525	105	AT 5 / 3350 FA**	670
AT 5 / 545	109	AT 5 / 3800 FA**	760
AT 5 / 600	120		
AT 5 / 610	122		
AT 5 / 620	124		
AT 5 / 630	126		
AT 5 / 660	132		
AT 5 / 670	134		
AT 5 / 690	138		
AT 5 / 710	142		

Preferred belt width\* in mm:  
10, 16, 25, 32, 50

\* Other dimensions upon request.  
\*\* Please request technical support from your Mulco sales partner.

**Order example**

CONTI® SYNCHROFLEX Timing Belt 10 AT5/450

Belt width in mm \_\_\_\_\_

Type/Pitch \_\_\_\_\_

Belt length in mm \_\_\_\_\_

## AT 5 Technical data

### 1. Tooth shear strength (specific belt tooth strength)



R.p.m. n [min <sup>-1</sup> ]	F <sub>Uspec</sub> [N/cm]	M <sub>spec</sub> [Ncm/cm]	P <sub>spec</sub> [W/cm]	R.p.m. n [min <sup>-1</sup> ]	F <sub>Uspec</sub> [N/cm]	M <sub>spec</sub> [Ncm/cm]	P <sub>spec</sub> [W/cm]
0	35,3	2,810	0,000	2000	21,9	1,740	3,650
20	34,9	2,780	0,058	2200	21,3	1,695	3,910
40	34,5	2,750	0,115	2400	20,8	1,654	4,160
60	34,1	2,720	0,171	2600	20,3	1,615	4,400
80	33,8	2,690	0,225	2800	19,84	1,579	4,63
100	33,5	2,660	0,279	3000	19,42	1,545	4,85
200	32,0	2,550	0,534	3200	19,01	1,513	5,07
300	30,9	2,460	0,771	3400	18,64	1,483	5,28
400	29,8	2,370	0,995	3600	18,28	1,454	5,48
500	29,0	2,300	1,207	3800	17,93	1,427	5,68
600	28,2	2,240	1,409	4000	17,61	1,401	5,87
700	27,5	2,190	1,603	4500	16,86	1,342	6,32
800	26,8	2,140	1,789	5000	16,18	1,288	6,74
900	26,3	2,090	1,969	5500	15,56	1,239	7,13
1000	25,7	2,050	2,140	6000	15,00	1,194	7,50
1100	25,2	2,010	2,310	6500	14,48	1,152	7,84
1200	24,8	1,970	2,480	7000	13,99	1,113	8,16
1300	24,3	1,936	2,640	7500	13,54	1,077	8,46
1400	23,9	1,903	2,790	8000	13,11	1,043	8,74
1500	23,5	1,872	2,940	8500	12,71	1,011	9,00
1600	23,2	1,843	3,090	9000	12,33	0,981	9,24
1700	22,8	1,816	3,230	9500	11,97	0,953	9,47
1800	22,5	1,789	3,370	10000	11,63	0,925	9,69
1900	22,2	1,764	3,510				

Rotational speeds over 10000 rpm and/or belt speeds over 80 m/s need special drive designs. Please ask our advice.

### 2. Tension member strength (permitted tensile force of the belt F<sub>zul</sub>), Belt weight

Belt width	b	[mm]	6	10	16	25	32	50	75	100
Tension member strength F <sub>zul</sub>		[N]	350	700	1260	2030	2660	4200	6370	8610
Belt weight	AT 5	[kg/m]	0,020	0,034	0,054	0,085	0,109	0,170	0,255	0,340

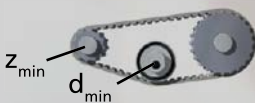
### 3. Flexibility (Minimum numbers of teeth, minimum diameter)

Timing pulley	z <sub>min</sub>	15		Drive type without contraflexure
Tension roller (smooth), running on teeth	d <sub>min</sub> [mm]	25		
Timing pulley	z <sub>min</sub>	20		Drive type with contraflexure
Tension roller (smooth), running on the back of the belt	d <sub>min</sub> [mm]	60		



# AT high performance Timing Belts

## AT 10 GEN III

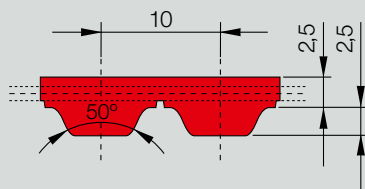

CONTI® SYNCHROFLEX Timing Belt (SFX) AT 10 GEN III

High performance AT profile with metric pitch and trapezoidal teeth.

**Standard version:**

- single-sided
- high performance polyurethane in red colour
- steel cord tension members with high density
- steel cord tension members in two-filament construction

**FN:** with profiles on the back of the belt

Type / Length* GEN III	Number of teeth	Type / Length* GEN III	Number of teeth
AT 10 / 440	44	AT 10 / 1150	115
AT 10 / 460	46	AT 10 / 1200	120
AT 10 / 500	50	AT 10 / 1210	121
AT 10 / 560	56	AT 10 / 1250	125
AT 10 / 570	57	AT 10 / 1280	128
AT 10 / 580	58	AT 10 / 1300	130
AT 10 / 600	60	AT 10 / 1320	132
AT 10 / 610	61	AT 10 / 1350	135
AT 10 / 660	66	AT 10 / 1360	136
AT 10 / 700	70	AT 10 / 1360 FN2	136
AT 10 / 730	73	AT 10 / 1400	140
AT 10 / 780	78	AT 10 / 1480	148
AT 10 / 800	80	AT 10 / 1500	150
AT 10 / 840	84	AT 10 / 1600	160
AT 10 / 840 FN2	84	AT 10 / 1700	170
AT 10 / 880	88	AT 10 / 1720	172
AT 10 / 890	89	AT 10 / 1800	180
AT 10 / 920	92	AT 10 / 1860	186
AT 10 / 960	96	AT 10 / 1940	194
AT 10 / 980	98	AT 10 / 2910 FN2	291
AT 10 / 1000	100		
AT 10 / 1010	101		
AT 10 / 1050	105		
AT 10 / 1080	108		
AT 10 / 1100	110		

Preferred belt width\* in mm:  
16, 25, 32, 50, 75, 100, 150

\* Other dimensions upon request.

**Order example**

CONTI® SYNCHROFLEX Timing Belt **32 AT10/800 GEN III**

Belt width in mm \_\_\_\_\_

Type/Pitch \_\_\_\_\_

Belt length in mm \_\_\_\_\_

Specification Generation III \_\_\_\_\_

# AT 10 GEN III Technical data

## 1. Tooth shear strength (specific belt tooth strength)



R.p.m. n [min <sup>-1</sup> ]	F <sub>Uspec</sub> [N/cm]	M <sub>spec</sub> [Ncm/cm]	P <sub>spec</sub> [W/cm]	R.p.m. n [min <sup>-1</sup> ]	F <sub>Uspec</sub> [N/cm]	M <sub>spec</sub> [Ncm/cm]	P <sub>spec</sub> [W/cm]
0	91,88	14,63	0,00	2000	50,38	8,03	16,80
20	90,50	14,41	0,30	2200	48,75	7,75	17,88
40	89,25	14,21	0,60	2400	47,25	7,51	18,88
60	88,13	14,01	0,88	2600	45,75	7,29	19,83
80	87,00	13,84	1,16	2800	44,38	7,08	20,73
100	85,88	13,68	1,43	3000	43,13	6,88	21,59
200	81,25	12,94	2,71	3200	42,00	6,69	22,40
300	77,63	12,35	3,88	3400	40,88	6,50	23,16
400	74,38	11,85	4,96	3600	39,88	6,34	23,89
500	71,75	11,41	5,98	3800	38,88	6,18	24,59
600	69,38	11,04	6,94	4000	37,88	6,03	25,25
700	67,13	10,69	7,84	4500	35,63	5,68	26,75
800	65,25	10,39	8,70	5000	33,63	5,36	28,13
900	63,50	10,10	9,53	5500	31,88	5,08	29,25
1000	61,88	9,85	10,31	6000	30,25	4,81	30,25
1100	60,38	9,61	11,08	6500	28,75	4,56	31,13
1200	59,00	9,39	11,80	7000	27,25	4,34	31,88
1300	57,75	9,19	12,50	7500	26,00	4,13	32,50
1400	56,50	8,99	13,18	8000	24,71	3,94	33,00
1500	55,38	8,80	13,84	8500	23,55	3,75	33,38
1600	54,25	8,64	14,46	9000	22,44	3,58	33,63
1700	53,25	8,48	15,08	9500	21,40	3,40	33,88
1800	52,25	8,31	15,68	10000	20,40	3,25	34,00
1900	51,25	8,16	16,25				

Rotational speeds over 10000 rpm and/or belt speeds over 60 m/s need special drive designs. Please ask our advice.

## 2. Tension member strength (permitted tensile force of the belt F<sub>zul</sub>), Belt weight

Belt width	b	[mm]	16	25	32	50	75	100	150
Tension member strength F <sub>zul</sub>		[N]	3000	5000	6750	10750	16500	22000	33500
Belt weight	AT 10 GEN III	[kg/m]	0,117	0,183	0,234	0,365	0,548	0,730	1,095

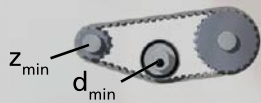
## 3. Flexibility (Minimum numbers of teeth, minimum diameter)

Timing pulley	z <sub>min</sub>	15		Drive type without contraflexure
Tension roller (smooth), running on teeth	d <sub>min</sub> [mm]	50		
Timing pulley	z <sub>min</sub>	25		Drive type with contraflexure
Tension roller (smooth), running on the back of the belt	d <sub>min</sub> [mm]	120		

# AT high performance Timing Belts

## AT 10

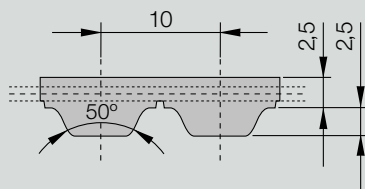

CONTI® SYNCHROFLEX Timing Belt (SFX) AT 10

High performance AT profile with metric pitch and trapezoidal teeth.

The technical data refer to standard polyurethane and standard steel cord tension members.

**Available versions:**

- single-sided
- with "E" tension member for a better flexibility
- with reinforced design
- with Aramide tension member
- polyurethane special materials upon request
- antistatic, coloured, mechanical reworked

**FN:** with profiles on the back of the belt

Type / Length*	Number of teeth	Type / Length*	Number of teeth
AT 10 / 440	44	AT 10 / 1150	115
AT 10 / 460	46	AT 10 / 1200	120
AT 10 / 500	50	AT 10 / 1210	121
AT 10 / 560	56	AT 10 / 1250	125
AT 10 / 570	57	AT 10 / 1280	128
AT 10 / 580	58	AT 10 / 1300	130
AT 10 / 600	60	AT 10 / 1320	132
AT 10 / 610	61	AT 10 / 1350	135
AT 10 / 660	66	AT 10 / 1360	136
AT 10 / 700	70	AT 10 / 1360 FN2	136
AT 10 / 730	73	AT 10 / 1400	140
AT 10 / 780	78	AT 10 / 1480	148
AT 10 / 800	80	AT 10 / 1500	150
AT 10 / 840	84	AT 10 / 1600	160
AT 10 / 840 FN2	84	AT 10 / 1700	170
AT 10 / 880	88	AT 10 / 1720	172
AT 10 / 890	89	AT 10 / 1800	180
AT 10 / 920	92	AT 10 / 1860	186
AT 10 / 960	96	AT 10 / 1940	194
AT 10 / 980	98	AT 10 / 2910 FN2	291
AT 10 / 1000	100		
AT 10 / 1010	101		
AT 10 / 1050	105		
AT 10 / 1080	108		
AT 10 / 1100	110		

Preferred belt width\* in mm:  
16, 25, 32, 50, 75, 100

\* Other dimensions upon request.

**Order example**

CONTI® SYNCHROFLEX Timing Belt 32 AT10/800

Belt width in mm \_\_\_\_\_

Type/Pitch \_\_\_\_\_

Belt length in mm \_\_\_\_\_

# AT 10 Technical data

## 1. Tooth shear strength (specific belt tooth strength)



R.p.m. n [min <sup>-1</sup> ]	F <sub>Uspec</sub> [N/cm]	M <sub>spec</sub> [Ncm/cm]	P <sub>spec</sub> [W/cm]	R.p.m. n [min <sup>-1</sup> ]	F <sub>Uspec</sub> [N/cm]	M <sub>spec</sub> [Ncm/cm]	P <sub>spec</sub> [W/cm]
0	73,5	11,70	0,000	2000	40,30	6,42	13,44
20	72,4	11,53	0,241	2200	39,00	6,20	14,30
40	71,4	11,37	0,476	2400	37,80	6,01	15,10
60	70,5	11,21	0,705	2600	36,60	5,83	15,86
80	69,6	11,07	0,928	2800	35,50	5,66	16,58
100	68,7	10,94	1,145	3000	34,50	5,50	17,27
200	65,0	10,35	2,170	3200	33,60	5,35	17,92
300	62,1	9,88	3,100	3400	32,70	5,20	18,53
400	59,5	9,48	3,970	3600	31,90	5,07	19,11
500	57,4	9,13	4,780	3800	31,10	4,94	19,67
600	55,5	8,83	5,550	4000	30,30	4,82	20,20
700	53,7	8,55	6,270	4500	28,50	4,54	21,40
800	52,2	8,31	6,960	5000	26,90	4,29	22,50
900	50,8	8,08	7,620	5500	25,50	4,06	23,40
1000	49,5	7,88	8,250	6000	24,20	3,85	24,20
1100	48,3	7,69	8,860	6500	23,00	3,65	24,90
1200	47,2	7,51	9,440	7000	21,80	3,47	25,50
1300	46,2	7,35	10,000	7500	20,80	3,30	26,00
1400	45,2	7,19	10,540	8000	19,77	3,15	26,40
1500	44,3	7,04	11,070	8500	18,84	3,00	26,70
1600	43,4	6,91	11,570	9000	17,95	2,86	26,90
1700	42,6	6,78	12,060	9500	17,12	2,72	27,10
1800	41,8	6,65	12,540	10000	16,32	2,60	27,20
1900	41,0	6,53	13,000				

Rotational speeds over 10000 rpm and/or belt speeds over 60 m/s need special drive designs. Please ask our advice.

## 2. Tension member strength (permitted tensile force of the belt F<sub>zul</sub>), Belt weight

Belt width	b	[mm]	16	25	32	50	75	100	150
Tension member strength F <sub>zul</sub>		[N]	2000	3500	4750	7750	12000	16000	24500
Belt weight	AT 10	[kg/m]	0,101	0,158	0,202	0,315	0,473	0,630	0,945

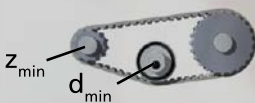
## 3. Flexibility (Minimum numbers of teeth, minimum diameter)

Timing pulley	z <sub>min</sub>	15		Drive type without contraflexure
Tension roller (smooth), running on teeth	d <sub>min</sub> [mm]	50		
Timing pulley	z <sub>min</sub>	25		Drive type with contraflexure
Tension roller (smooth), running on the back of the belt	d <sub>min</sub> [mm]	120		

# ATP high performance Timing Belts

## ATP 10 GEN III

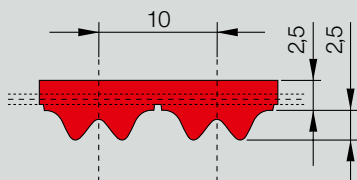

CONTI® SYNCHROFLEX Timing Belt (SFX) ATP 10 GEN III

High performance ATP profile with metric pitch and optimised meshing of the double engagement toothform.

**Standard version**

- single-sided
- high performance polyurethane in red colour
- steel cord tension members with high density
- steel cord tension members in two-filament construction

Type / Length* GEN III	Number of teeth	Type / Length* GEN III	Number of teeth
ATP 10 / 630	63	ATP 10 / 1280	128
ATP 10 / 660	66	ATP 10 / 1400	140
ATP 10 / 700	70	ATP 10 / 1650	165
ATP 10 / 780	78	ATP 10 / 1800	180
ATP 10 / 840	84		
ATP 10 / 890	89		
ATP 10 / 920	92		
ATP 10 / 1010	101		
ATP 10 / 1080	108		
ATP 10 / 1150	115		

Preferred belt width\* in mm:  
16, 25, 32, 50, 75, 100, 150

\* Other dimensions upon request.

**Order example**

CONTI® SYNCHROFLEX Timing Belt 32 ATP10/780 GEN III

Belt width in mm \_\_\_\_\_

Type/Pitch \_\_\_\_\_

Belt length in mm \_\_\_\_\_

Specification Generation III \_\_\_\_\_



# ATP 10 GEN III Technical data

## 1. Tooth shear strength (specific belt tooth strength)



R.p.m. n [min <sup>-1</sup> ]	F <sub>Uspec</sub> [N/cm]	M <sub>spec</sub> [Ncm/cm]	P <sub>spec</sub> [W/cm]	R.p.m. n [min <sup>-1</sup> ]	F <sub>Uspec</sub> [N/cm]	M <sub>spec</sub> [Ncm/cm]	P <sub>spec</sub> [W/cm]
0	105,050	16,713	0,000	2000	57,636	9,170	19,205
20	103,508	16,468	0,345	2200	55,722	8,865	20,425
40	102,064	16,238	0,680	2400	53,957	8,584	21,575
60	100,706	16,023	1,007	2600	52,318	8,324	22,663
80	99,424	15,818	1,326	2800	50,790	8,081	23,694
100	98,210	15,626	1,637	3000	49,358	7,853	24,671
150	95,432	15,183	2,385	3200	48,010	7,638	25,597
200	92,956	14,790	3,098	3400	46,737	7,436	26,476
300	88,706	14,110	4,433	3600	45,532	7,245	27,310
400	85,093	13,538	5,671	3800	44,387	7,062	28,102
500	81,989	13,045	6,830	4000	43,297	6,888	28,855
600	79,257	12,609	7,923	4500	40,780	6,488	30,575
700	76,817	12,222	8,985	5000	38,513	6,127	32,084
800	74,614	11,871	9,945	5500	36,452	5,799	33,403
900	72,604	11,551	10,887	6000	34,561	5,499	34,549
1000	70,758	11,257	11,789	6500	32,815	5,221	35,538
1100	69,049	10,986	12,654	7000	31,194	4,963	36,380
1200	67,461	10,733	13,487	7500	29,679	4,722	37,087
1300	65,975	10,496	14,290	8000	28,260	4,496	37,666
1400	64,580	10,275	15,063	8500	26,923	4,283	38,128
1500	63,265	10,065	15,811	9000	25,661	4,082	38,477
1600	62,022	9,868	16,534	9500	24,464	3,892	38,721
1700	60,844	9,680	17,234	10000	23,328	3,711	38,865
1800	59,723	9,502	17,911				
1900	58,655	9,332	18,568				

Rotational speeds over 10000 rpm and/or belt speeds over 60 m/s need special drive designs. Please ask our advice.

## 2. Tension member strength (permitted tensile force of the belt F<sub>zul</sub>), Belt weight

Belt width	b	[mm]	16	25	32	50	75	100	150
Tension member strength F <sub>zul</sub>		[N]	3000	5000	6750	10750	16500	22000	33500
Belt weight	ATP 10 GEN III	[kg/m]	0,109	0,170	0,218	0,340	0,510	0,680	1,020

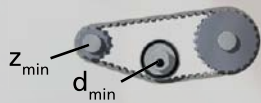
## 3. Flexibility (Minimum numbers of teeth, minimum diameter)

Timing pulley	z <sub>min</sub>	15		Drive type without contraflexure
Tension roller (smooth), running on teeth	d <sub>min</sub> [mm]	50		
Timing pulley	z <sub>min</sub>	25		Drive type with contraflexure
Tension roller (smooth), running on the back of the belt	d <sub>min</sub> [mm]	120		

# ATP high performance Timing Belts

## ATP 10

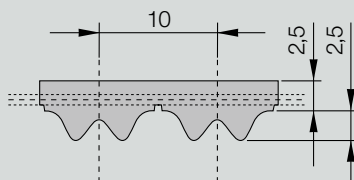

CONTI® SYNCHROFLEX Timing Belt (SFX) ATP 10

High performance ATP profile with metric pitch and optimised meshing of the double engagement toothform.

The technical data refer to standard polyurethane and standard steel cord tension members.

**Available versions:**

- single-sided
- with “E” tension member for a better flexibility
- with reinforced tension member design
- polyurethane special materials upon request (Standard: 93ShA, colour: red)
- antistatic, coloured, mechanical reworked

Type / Length*	Number of teeth	Type / Length*	Number of teeth
ATP 10 / 630	63	ATP 10 / 1280	128
ATP 10 / 660	66	ATP 10 / 1400	140
ATP 10 / 700	70	ATP 10 / 1650	165
ATP 10 / 780	78	ATP 10 / 1800	180
ATP 10 / 840	84		
ATP 10 / 890	89		
ATP 10 / 920	92		
ATP 10 / 1010	101		
ATP 10 / 1080	108		
ATP 10 / 1150	115		

Preferred belt width\* in mm:  
16, 25, 32, 50, 75, 100

\* Other dimensions upon request.

**Order example**

CONTI® SYNCHROFLEX Timing Belt 32 ATP10/780

Belt width in mm \_\_\_\_\_

Type/Pitch \_\_\_\_\_

Belt length in mm \_\_\_\_\_

# ATP 10 Technical data

## 1. Tooth shear strength (specific belt tooth strength)

R.p.m. n [min <sup>-1</sup> ]	F <sub>Uspec</sub> [N/cm]	M <sub>spec</sub> [Ncm/cm]	P <sub>spec</sub> [W/cm]
0	95,500	15,199	0,000
20	94,098	14,976	0,314
40	92,785	14,767	0,619
60	91,551	14,571	0,915
80	90,385	14,385	1,205
100	89,282	14,210	1,488
150	86,756	13,808	2,169
200	84,505	13,449	2,817
300	80,642	12,835	4,032
400	77,357	12,312	5,157
500	74,535	11,863	6,211
600	72,052	11,467	7,205
700	69,834	11,114	8,147
730	69,212	11,015	8,420
800	67,831	10,796	9,043
900	66,004	10,505	9,900
1000	64,325	10,238	10,720
1100	62,772	9,990	11,507
1200	61,328	9,761	12,265
1300	59,977	9,546	12,994
1400	58,709	9,344	13,698
1460	57,984	9,228	14,108
1500	57,514	9,154	14,377
1600	56,348	8,968	15,025
1700	55,313	8,803	15,671
1800	54,294	8,641	16,287



R.p.m. n [min <sup>-1</sup> ]	F <sub>Uspec</sub> [N/cm]	M <sub>spec</sub> [Ncm/cm]	P <sub>spec</sub> [W/cm]
1900	53,323	8,487	16,884
2000	52,396	8,339	17,464
2200	50,656	8,062	18,572
2400	49,052	7,807	19,619
2600	47,562	7,570	20,609
2800	46,173	7,349	21,546
2880	45,642	7,264	21,907
3000	44,871	7,141	22,434
3200	43,645	6,946	23,276
3400	42,488	6,762	24,075
3600	41,393	6,588	24,834
3800	40,352	6,422	25,554
4000	39,361	6,264	26,239
4500	37,073	5,900	27,803
5000	35,012	5,572	29,175
5500	33,138	5,274	30,374
6000	31,419	5,000	31,417
6500	29,832	4,748	32,316
7000	28,358	4,513	33,082
7500	26,981	4,294	33,724
8000	25,691	4,089	34,252
8500	24,475	3,895	34,670
9000	23,328	3,713	34,989
9500	22,240	3,540	35,211
10000	21,207	3,375	35,342

Rotational speeds over 10000 rpm and/or belt speeds over 60 m/s need special drive designs. Please ask for our advice.

## 2. Tension member strength (permitted tensile force of the belt F<sub>zul</sub>), Belt weight

Belt width	b	[mm]	16	25	32	50	75	100	150
Tension member strength F <sub>zul</sub>		[N]	2000	3500	4750	7750	12000	16000	24500
Belt weight	ATP 10	[kg/m]	0,096	0,150	0,192	0,300	0,450	0,600	0,900

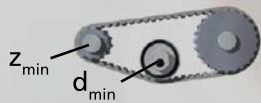
## 3. Flexibility (Minimum numbers of teeth, minimum diameter)

Timing pulley	z <sub>min</sub>	15		Drive type without contraflexure
Tension roller (smooth), running on teeth	d <sub>min</sub> [mm]	50		
Timing pulley	z <sub>min</sub>	25		Drive type with contraflexure
Tension roller (smooth), running on the back of the belt	d <sub>min</sub> [mm]	120		

# ATP high performance Timing Belts

## ATP 15 GEN III

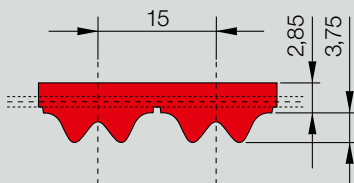

CONTI® SYNCHROFLEX Timing Belt (SFX) ATP 15 GEN III

High performance ATP profile with metric pitch and optimised meshing of the double engagement toothform.

**Standard version**

- single-sided
- high performance polyurethane in red colour
- steel cord tension members with high density
- steel cord tension members in two-filament construction

Type / Length* GEN III	Number of teeth
ATP 15 / 1125	75
ATP 15 / 1185	79

Preferred belt width\* in mm:  
25, 32, 50, 75, 100, 150

Type / Length* GEN III	Number of teeth
ATP 15 / 1260	84
ATP 15 / 1560	104

\* Other dimensions upon request.

**Order example**

CONTI® SYNCHROFLEX Timing Belt 32 ATP15/1260 GEN III

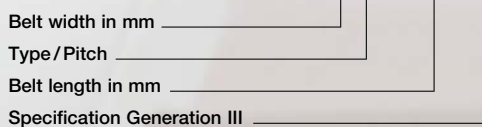

# ATP 15 GEN III Technical data

## 1. Tooth shear strength (specific belt tooth strength)



R.p.m. n [min <sup>-1</sup> ]	F <sub>Uspec</sub> [N/cm]	M <sub>spec</sub> [Ncm/cm]	P <sub>spec</sub> [W/cm]	R.p.m. n [min <sup>-1</sup> ]	F <sub>Uspec</sub> [N/cm]	M <sub>spec</sub> [Ncm/cm]	P <sub>spec</sub> [W/cm]
0	157,672	37,641	0,000	2200	76,062	18,158	41,834
20	155,054	37,016	0,775	2400	73,182	17,471	43,909
40	152,609	36,433	1,526	2600	70,510	16,833	45,831
60	150,315	35,885	2,255	2800	68,018	16,238	47,612
80	148,155	35,369	2,963	3000	65,683	15,681	49,262
100	146,114	34,882	3,653	3200	63,486	15,156	50,789
150	141,455	33,770	5,305	3400	61,413	14,661	52,201
200	137,318	32,782	6,866	3600	59,449	14,192	53,504
300	130,215	31,087	9,766	3800	57,584	13,747	54,705
400	124,258	29,664	12,426	4000	55,809	13,323	55,809
500	119,128	28,440	14,891	4500	51,711	12,345	58,175
600	114,623	27,364	17,193	5000	48,022	11,464	60,027
700	110,606	26,405	19,356	5500	44,667	10,663	61,417
800	106,984	25,540	21,397	6000	41,591	9,929	62,386
900	103,684	24,753	23,329	6500	38,751	9,251	62,970
1000	100,564	24,029	25,163	7000	36,113	8,621	63,198
1100	97,853	23,361	26,910	7500	33,651	8,034	63,095
1200	95,250	22,739	28,575	8000	31,342	7,482	62,684
1300	92,817	22,159	30,166	8500	29,169	6,964	61,984
1400	90,535	21,614	31,687	9000	27,116	6,474	61,012
1500	88,385	21,100	33,144	9500	25,171	6,009	59,782
1600	86,353	20,615	34,541	10000	23,324	5,568	58,309
1700	84,427	20,155	35,881				
1800	82,596	19,718	37,168				
1900	80,851	19,302	38,404				
2000	79,185	18,904	39,592				

Rotational speeds over 10000 rpm and/or belt speeds over 50 m/s need special drive designs. Please ask for our advice.

## 2. Tension member strength (permitted tensile force of the belt F<sub>zul</sub>), Belt weight

Belt width	b	[mm]	25	32	50	75	100	150
Tension member strength F <sub>zul</sub>		[N]	6300	8550	13950	21600	28800	44100
Belt weight	ATP 15 GEN III	[kg/m]	0,218	0,279	0,436	0,654	0,872	1,308

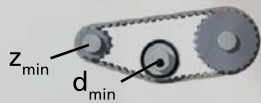
## 3. Flexibility (Minimum numbers of teeth, minimum diameter)

Timing pulley	z <sub>min</sub>	20		Drive type without contraflexure
Tension roller (smooth), running on teeth	d <sub>min</sub> [mm]	100		
Timing pulley	z <sub>min</sub>	30		Drive type with contraflexure
Tension roller (smooth), running on the back of the belt	d <sub>min</sub> [mm]	160		

# ATP high performance Timing Belts

## ATP 15

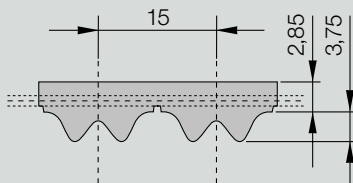

CONTI® SYNCHROFLEX Timing Belt (SFX) ATP 15

High performance ATP profile with metric pitch and optimised meshing of the double engagement toothform.

**Available versions:**

- single-sided
- with “E” tension member for a better flexibility
- with reinforced tension member design
- polyurethane special materials upon request (Standard: 93ShA, colour: red)
- antistatic, coloured, mechanical reworked

Type / Length* GEN III	Number of teeth
ATP 15 / 1125	75
ATP 15 / 1185	79

Type / Length* GEN III	Number of teeth
ATP 15 / 1260	84
ATP 15 / 1560	104

Preferred belt width\* in mm:  
25, 32, 50, 75, 100, 150

\* Other dimensions upon request.

**Order example**

CONTI® SYNCHROFLEX Timing Belt 32 ATP15/1260

Belt width in mm \_\_\_\_\_

Type/Pitch \_\_\_\_\_

Belt length in mm \_\_\_\_\_



# ATP 15 Technical data

## 1. Tooth shear strength (specific belt tooth strength)



R.p.m. n [min <sup>-1</sup> ]	F <sub>Uspec</sub> [N/cm]	M <sub>spec</sub> [Ncm/cm]	P <sub>spec</sub> [W/cm]	R.p.m. n [min <sup>-1</sup> ]	F <sub>Uspec</sub> [N/cm]	M <sub>spec</sub> [Ncm/cm]	P <sub>spec</sub> [W/cm]
0	143,325	34,216	0,000	2200	69,141	16,506	38,027
20	140,945	33,648	0,705	2400	66,523	15,881	39,914
40	138,722	33,117	1,387	2600	64,094	15,301	41,661
60	136,637	32,620	2,050	2800	61,828	14,760	43,280
80	134,674	32,151	2,693	3000	59,706	14,254	44,779
100	132,818	31,708	3,320	3200	57,709	13,777	46,167
150	128,584	30,697	4,822	3400	55,824	13,327	47,451
200	124,832	29,799	6,241	3600	54,040	12,901	48,636
300	118,367	28,258	8,877	3800	52,345	12,496	49,727
400	112,952	26,965	11,295	4000	50,731	12,111	50,731
500	108,288	25,852	13,536	4500	47,006	11,222	52,881
600	104,193	24,874	15,629	5000	43,652	10,421	54,565
700	100,542	24,003	17,595	5500	40,602	9,693	55,828
800	97,249	23,216	19,450	6000	37,806	9,026	56,709
900	94,249	22,500	21,206	6500	35,225	8,409	57,240
1000	91,495	21,843	22,874	7000	32,827	7,837	57,447
1100	88,949	21,235	24,461	7500	30,589	7,303	57,354
1200	86,583	20,670	25,975	8000	28,490	6,802	56,980
1300	84,372	20,142	27,421	8500	26,515	6,330	56,344
1400	82,297	19,647	28,804	9000	24,649	5,884	55,460
1500	80,343	19,180	30,128	9500	22,881	5,462	54,342
1600	78,495	18,739	31,398	10000	21,201	5,061	53,003
1700	76,745	18,321	32,616				
1800	75,080	17,924	33,786				
1900	73,494	17,545	34,910				
2000	71,980	17,184	35,990				

Rotational speeds over 10000 rpm and/or belt speeds over 50 m/s need special drive designs. Please ask for our advice.

## 2. Tension member strength (permitted tensile force of the belt F<sub>zul</sub>), Belt weight

Belt width	b	[mm]	25	32	50	75	100	150
Tension member strength F <sub>zul</sub>		[N]	4950	6750	11250	17550	23850	36450
Belt weight	ATP 15	[kg/m]	0,200	0,256	0,400	0,600	0,800	1,200

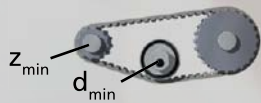
## 3. Flexibility (Minimum numbers of teeth, minimum diameter)

Timing pulley	z <sub>min</sub>	20		Drive type without contraflexure
Tension roller (smooth), running on teeth	d <sub>min</sub> [mm]	100		
Timing pulley	z <sub>min</sub>	30		Drive type with contraflexure
Tension roller (smooth), running on the back of the belt	d <sub>min</sub> [mm]	60		

# AT high performance Timing Belts

## AT 20 GEN III

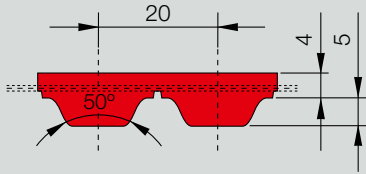

CONTI® SYNCHROFLEX Timing Belt (SFX) AT 20 GEN III

High performance AT profile with metric pitches and trapezoidal teeth.

**Standard version:**

- single-sided
- high performance polyurethane in red colour
- steel cord tension members with high density
- steel cord tension members in two-filament construction

Type / Length* GEN III	Number of teeth	Type / Length* GEN III	Number of teeth
AT 20 / 1000**	50	AT 20 / 1960**	98
AT 20 / 1100	55		
AT 20 / 1200**	60		
AT 20 / 1260	63		
AT 20 / 1500**	75		
AT 20 / 1600**	80		
AT 20 / 1700	85		
AT 20 / 1760**	88		
AT 20 / 1800	90		
AT 20 / 1900**	95		

**Preferred belt width\* in mm:**  
32, 50, 75, 100

\* Other dimensions upon request.  
\*\* In combination with reduced pulley gap please ask for technical support from your Mulco sales partner.

**Order example**

CONTI® SYNCHROFLEX Timing Belt **32 AT20/1000 GEN III**

Belt width in mm \_\_\_\_\_

Type/Pitch \_\_\_\_\_

Belt length in mm \_\_\_\_\_

Specification Generation III \_\_\_\_\_

# AT 20 GEN III Technical data

## 1. Tooth shear strength (specific belt tooth strength)



R.p.m. n [min <sup>-1</sup> ]	F <sub>Uspec</sub> [N/cm]	M <sub>spec</sub> [Ncm/cm]	P <sub>spec</sub> [W/cm]	R.p.m. n [min <sup>-1</sup> ]	F <sub>Uspec</sub> [N/cm]	M <sub>spec</sub> [Ncm/cm]	P <sub>spec</sub> [W/cm]
0	183,750	58,489	0,000	2000	83,380	26,541	55,587
20	180,310	57,395	1,202	2200	79,444	25,288	58,259
40	177,108	56,375	2,361	2400	75,816	24,133	60,653
60	174,112	55,422	3,482	2600	72,451	23,062	62,791
80	171,298	54,526	4,568	2800	69,314	22,063	64,693
100	168,645	53,682	5,622	3000	66,375	21,128	66,375
150	162,609	51,760	8,130	3200	63,612	20,248	67,852
200	157,268	50,060	10,485	3400	61,003	19,418	69,137
300	148,138	47,154	14,814	3600	58,534	18,632	70,241
400	140,512	44,726	18,735	3800	56,189	17,886	71,173
500	133,963	42,642	22,327	4000	53,957	17,175	71,943
600	128,226	40,816	25,645	4500	48,806	15,535	73,209
700	123,120	39,190	28,728	5000	44,170	14,060	73,617
800	118,521	37,726	31,606	5500	39,955	12,718	73,251
900	114,336	36,394	34,301	6000	36,091	11,488	72,183
1000	110,498	35,173	36,833	6500	32,525	10,353	70,470
1100	106,953	34,044	39,216				
1200	103,660	32,996	41,464				
1300	100,585	32,017	43,587				
1400	97,701	31,099	45,594				
1500	94,986	30,235	47,493				
1600	92,421	29,419	49,291				
1700	89,990	28,645	50,995				
1800	87,681	27,910	52,608				
1900	85,481	27,209	54,138				

Rotational speeds over 6500 rpm and/or belt speeds over 40 m/s need special drive designs. Please ask for our advice.

## 2. Tension member strength (permitted tensile force of the belt F<sub>zul</sub>), Belt weight

Belt width	b	[mm]	25	32	50	75	100	150
Tension member strength F <sub>zul</sub>		[N]	6300	8550	13950	21600	28800	44100
Belt weight	AT 20 GEN III	[kg/m]	0,290	0,371	0,583	0,87	1,16	1,74

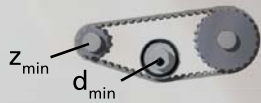
## 3. Flexibility (Minimum numbers of teeth, minimum diameter)

Timing pulley	Z <sub>min</sub>	18		Drive type without contraflexure
Tension roller (smooth), running on teeth	d <sub>min</sub> [mm]	120		
Timing pulley	Z <sub>min</sub>	25		Drive type with contraflexure
Tension roller (smooth), running on the back of the belt	d <sub>min</sub> [mm]	180		

# AT high performance Timing Belts

## AT 20

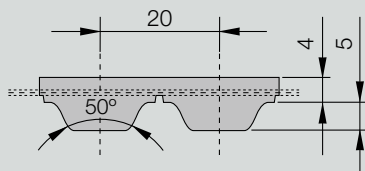

CONTI® SYNCHROFLEX Timing Belt (SFX) AT 20

High performance AT profile with metric pitches and trapezoidal teeth.

The technical data refer to standard polyurethane and standard steel cord tension members.

**Available versions:**

- single-sided
- polyurethane special materials upon request
- antistatic, coloured, mechanical reworked

Type / Length*	Number of teeth	Type / Length*	Number of teeth
AT 20 / 1000**	50	AT 20 / 1960**	98
AT 20 / 1100	55		
AT 20 / 1200**	60		
AT 20 / 1260	63		
AT 20 / 1500**	75		
AT 20 / 1600**	80		
AT 20 / 1700	85		
AT 20 / 1760**	88		
AT 20 / 1800	90		
AT 20 / 1900**	95		

**Preferred belt width\* in mm:**  
32, 50, 75, 100

\* Other dimensions upon request.  
\*\* In combination with reduced pulley gap please ask for technical support from your Mulco sales partner.

**Order example**

CONTI® SYNCHROFLEX Timing Belt 50 AT20/1500

Belt width in mm \_\_\_\_\_  
 Type/Pitch \_\_\_\_\_  
 Belt length in mm \_\_\_\_\_

# AT 20 Technical data

## 1. Tooth shear strength (specific belt tooth strength)

R.p.m. n [min <sup>-1</sup> ]	F <sub>Uspec</sub> [N/cm]	M <sub>spec</sub> [Ncm/cm]	P <sub>spec</sub> [W/cm]
0	147,0	46,80	0,000
20	144,2	45,90	0,962
40	141,7	45,10	1,889
60	139,3	44,30	2,790
80	137,0	43,60	3,650
100	134,9	42,90	4,500
200	125,8	40,00	8,390
300	118,5	37,70	11,850
400	112,4	35,80	14,990
500	107,2	34,10	17,860
600	102,6	32,70	20,500
700	98,5	31,40	23,000
800	94,8	30,20	25,300
900	91,5	29,10	27,400
1000	88,4	28,10	29,500
1100	85,6	27,20	31,400
1200	82,9	26,40	33,200
1300	80,5	25,60	34,900
1400	78,2	24,90	36,500
1500	76,0	24,20	38,000
1600	73,9	23,50	39,400
1700	72,0	22,90	40,800
1800	70,1	22,30	42,100
1900	68,4	21,80	43,300

R.p.m. n [min <sup>-1</sup> ]	F <sub>Uspec</sub> [N/cm]	M <sub>spec</sub> [Ncm/cm]	P <sub>spec</sub> [W/cm]
2000	66,7	21,20	44,500
2200	63,6	20,20	46,600
2400	60,7	19,31	48,500
2600	58,0	18,45	50,200
2800	55,5	17,65	51,800
3000	53,1	16,90	53,100
3200	50,9	16,20	54,300
3400	48,8	15,53	55,300
3600	46,8	14,91	56,200
3800	45,0	14,31	56,900
4000	43,2	13,74	57,600
4500	39,0	12,43	58,600
5000	35,3	11,25	58,800
5500	32,0	10,17	60,600
6000	28,9	9,19	61,700
6500	26,0	8,28	62,400

Rotational speeds over 6500 rpm and/or belt speeds over 40 m/s need special drive designs. Please ask for our advice.

## 2. Tension member strength (permitted tensile force of the belt F<sub>zul</sub>), Belt weight

Belt width	b	[mm]	32	50	75	100	150
Tension member strength F <sub>zul</sub>		[N]	6750	11250	17550	23850	36450
Belt weight	AT 20	[kg/m]	0,339	0,530	0,795	1,060	1,590

## 3. Flexibility (Minimum numbers of teeth, minimum diameter)

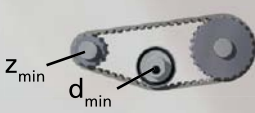
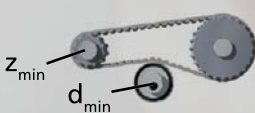
Timing pulley	Z <sub>min</sub>	18		Drive type without contraflexure
Tension roller (smooth), running on teeth	d <sub>min</sub> [mm]	120		
Timing pulley	Z <sub>min</sub>	25		Drive type with contraflexure
Tension roller (smooth), running on the back of the belt	d <sub>min</sub> [mm]	180		

# T standard Timing Belts

## T 2

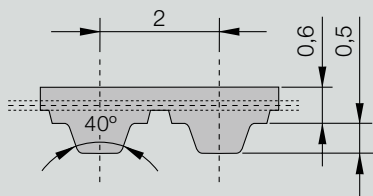

CONTI® SYNCHROFLEX Timing Belt (SFX) T 2

Standard T profile with metric pitch and trapezoidal teeth.

The technical data refer to standard polyurethane and standard steel cord tension members.

**Available versions:**

- single-sided
- with Aramide tension member
- polyurethane special materials upon request
- antistatic, coloured, mechanical reworked

**FA:** with bigger back thickness

**FN:** with profiles on the back of the belt

Type / Length*	Number of teeth	Type / Length*	Number of teeth
T 2 / 68	34	T 2 / 220 FN2	110
T 2 / 90	45	T 2 / 240	120
T 2 / 108	54	T 2 / 256	128
T 2 / 118	59	T 2 / 262	131
T 2 / 120	60	T 2 / 280	140
T 2 / 120 FA	60	T 2 / 292	146
T 2 / 138	69	T 2 / 320	160
T 2 / 140	70	T 2 / 360	180
T 2 / 144	72	T 2 / 600	300
T 2 / 150	75	T 2 / 710	355
T 2 / 160	80	T 2 / 710 FA	355
T 2 / 180	90	T 2 / 1296 FA	648
T 2 / 200	100		
T 2 / 220	110		
T 2 / 220 FA	110		

Preferred belt width\* in mm:  
4, 6, 10

\* Other dimensions upon request.

**Order example**

CONTI® SYNCHROFLEX Timing Belt 6 T2/240

Belt width in mm \_\_\_\_\_  
 Type/Pitch \_\_\_\_\_  
 Belt length in mm \_\_\_\_\_



## T 2 Technical data

### 1. Tooth shear strength (specific belt tooth strength)

R.p.m. n [min <sup>-1</sup> ]	F <sub>Uspec</sub> [N/cm]	M <sub>spec</sub> [Ncm/cm]	P <sub>spec</sub> [W/cm]
0	6,58	0,209	0,000
20	6,36	0,202	0,004
40	6,18	0,197	0,008
60	6,03	0,192	0,012
80	5,90	0,188	0,016
100	5,79	0,184	0,019
150	5,56	0,177	0,028
200	5,38	0,171	0,036
300	5,10	0,162	0,051
400	4,89	0,156	0,065
500	4,72	0,150	0,079
600	4,58	0,146	0,092
700	4,45	0,142	0,104
730	4,42	0,141	0,108
800	4,35	0,138	0,116
900	4,25	0,135	0,127
1000	4,16	0,132	0,139
1100	4,08	0,130	0,150
1200	4,01	0,128	0,160
1300	3,94	0,125	0,171
1400	3,88	0,124	0,181
1460	3,85	0,123	0,187
1500	3,82	0,122	0,191
1600	3,77	0,120	0,201
1700	3,72	0,118	0,211
1800	3,67	0,117	0,220
1900	3,62	0,115	0,229
2000	3,58	0,114	0,239
2200	3,50	0,111	0,257



R.p.m. n [min <sup>-1</sup> ]	F <sub>Uspec</sub> [N/cm]	M <sub>spec</sub> [Ncm/cm]	P <sub>spec</sub> [W/cm]
2400	3,42	0,109	0,274
2500	3,39	0,108	0,282
2600	3,35	0,107	0,290
2800	3,29	0,105	0,307
2880	3,26	0,104	0,313
3000	3,23	0,103	0,323
3200	3,17	0,101	0,338
3400	3,12	0,099	0,354
3600	3,07	0,098	0,368
3800	3,02	0,096	0,383
4000	2,98	0,095	0,397
4500	2,88	0,092	0,432
5000	2,78	0,088	0,463
5500	2,70	0,086	0,495
6000	2,63	0,084	0,526
6500	2,56	0,081	0,555
7000	2,49	0,079	0,581
7500	2,43	0,077	0,607
8000	2,37	0,075	0,632
8500	2,32	0,074	0,657
9000	2,27	0,072	0,681
9500	2,22	0,071	0,703
10000	2,18	0,069	0,727
12000	2,02	0,064	0,808
15000	1,82	0,058	0,910
18000	1,66	0,053	0,996
20000	1,57	0,050	1,047

Rotational speeds over 20000 rpm and/or belt speeds over 80 m/s need special drive designs. Please ask for our advice.

### 2. Tension member strength (permitted tensile force of the belt F<sub>zul</sub>), Belt weight

Belt width	b	[mm]	4	6	10	16	25	32
Tension member strength F <sub>zul</sub>		[N]	39	65	117	195	312	403
Belt weight	T 2	[kg/m]	0,004	0,007	0,011	0,018	0,028	0,035

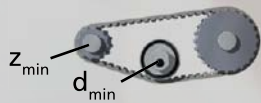
### 3. Flexibility (Minimum numbers of teeth, minimum diameter)

Timing pulley	Z <sub>min</sub>	10		Drive type without contraflexure
Tension roller (smooth), running on teeth	d <sub>min</sub> [mm]	15		
Timing pulley	Z <sub>min</sub>	18		Drive type with contraflexure
Tension roller (smooth), running on the back of the belt	d <sub>min</sub> [mm]	15		

# T standard Timing Belts

## T 2,5 / T 2,5-DL

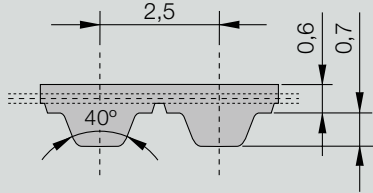

CONTI® SYNCHROFLEX Timing Belt (SFX) T 2,5

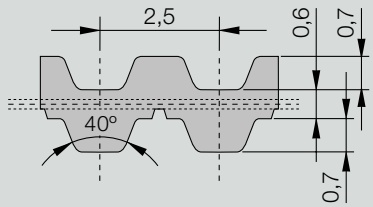

CONTI® SYNCHROFLEX Timing Belt (SFX) T 2,5-DL

Standard T profile according to DIN 7721 with metric pitch and trapezoidal teeth.

The technical data refer to standard polyurethane and standard steel cord tension members.

**Available versions:**

- single-sided (as standard)
- with Aramide tension member
- polyurethane special materials upon request
- antistatic, coloured, mechanical reworked

**DL:** double-sided

**FA:** with bigger back thickness

**FN:** with profiles on the back of the belt

Type / Length*	Number of teeth	Type / Length*	Number of teeth
T 2,5 / 55 FA	22	T 2,5 / 317,5 DL	127
T 2,5 / 75 FN2	30	T 2,5 / 330	132
T 2,5 / 120	48	T 2,5 / 380	152
T 2,5 / 145	58	T 2,5 / 395	158
T 2,5 / 160	64	T 2,5 / 400 FA	160
T 2,5 / 160 FA	64	T 2,5 / 415 DL	166
T 2,5 / 177,5	71	T 2,5 / 420	168
T 2,5 / 180	72	T 2,5 / 420 FN168	168
T 2,5 / 182,5	73	T 2,5 / 457,5 DL	183
T 2,5 / 200	80	T 2,5 / 480	192
T 2,5 / 210 FA	84	T 2,5 / 500	200
T 2,5 / 210 FN28	84	T 2,5 / 500 FA	200
T 2,5 / 220 FN3	88	T 2,5 / 540	216
T 2,5 / 225	90	T 2,5 / 540 FA	216
T 2,5 / 230	92	T 2,5 / 600 FA	240
T 2,5 / 230 FA	92	T 2,5 / 620	248
T 2,5 / 245	98	T 2,5 / 650	260
T 2,5 / 250	100	T 2,5 / 650 FN2	260
T 2,5 / 265	106	T 2,5 / 780	312
T 2,5 / 285	114	T 2,5 / 780 FA	312
T 2,5 / 285 FA	114	T 2,5 / 950	380
T 2,5 / 290	116	T 2,5 / 1300	520
T 2,5 / 305	122	T 2,5 / 1300 FA	520
T 2,5 / 305 FA	122	T 2,5 / 1350 FA	540
T 2,5 / 305 FN1	122	T 2,5 / 1475 FA	590
T 2,5 / 317,5	127		

Preferred belt width\* in mm:  
4, 6, 10

\* Other dimensions upon request.

**Order example**

CONTI® SYNCHROFLEX Timing Belt 10 T2,5/380

Belt width in mm \_\_\_\_\_  
 Type/Pitch \_\_\_\_\_  
 Belt length in mm \_\_\_\_\_

# T 2,5 / T 2,5-DL Technical data

## 1. Tooth shear strength (specific belt tooth strength)



R.p.m. n [min <sup>-1</sup> ]	F <sub>Uspec</sub> [N/cm]	M <sub>spec</sub> [Ncm/cm]	P <sub>spec</sub> [W/cm]	R.p.m. n [min <sup>-1</sup> ]	F <sub>Uspec</sub> [N/cm]	M <sub>spec</sub> [Ncm/cm]	P <sub>spec</sub> [W/cm]
0	9,03	0,359	0,000	2500	4,65	0,185	0,484
20	8,72	0,347	0,007	2600	4,60	0,183	0,499
40	8,48	0,337	0,014	2800	4,51	0,180	0,527
60	8,28	0,329	0,021	2880	4,48	0,178	0,538
80	8,10	0,322	0,027	3000	4,43	0,176	0,554
100	7,95	0,316	0,033	3200	4,36	0,173	0,581
150	7,64	0,304	0,048	3400	4,28	0,170	0,607
200	7,39	0,294	0,062	3600	4,22	0,168	0,632
300	7,01	0,279	0,088	3800	4,15	0,165	0,657
400	6,71	0,267	0,112	4000	4,09	0,163	0,682
500	6,48	0,258	0,135	4500	3,95	0,157	0,740
600	6,28	0,250	0,157	5000	3,82	0,152	0,796
700	6,11	0,243	0,178	5500	3,71	0,148	0,850
730	6,07	0,241	0,185	6000	3,60	0,143	0,901
800	5,97	0,237	0,199	6500	3,51	0,140	0,950
900	5,83	0,232	0,219	7000	3,42	0,136	0,997
1000	5,71	0,227	0,238	7500	3,33	0,133	1,042
1100	5,61	0,223	0,257	8000	3,26	0,130	1,086
1200	5,51	0,219	0,275	8500	3,18	0,127	1,128
1300	5,41	0,215	0,293	9000	3,11	0,124	1,168
1400	5,33	0,212	0,311	9500	3,05	0,121	1,207
1460	5,28	0,210	0,321	10000	2,99	0,119	1,245
1500	5,25	0,209	0,328	12000	2,77	0,110	1,384
1600	5,17	0,206	0,345	15000	2,50	0,099	1,561
1700	5,10	0,203	0,361	18000	2,28	0,091	1,708
1800	5,04	0,200	0,378	20000	2,15	0,086	1,791
1900	4,97	0,198	0,394				
2000	4,91	0,195	0,409				
2200	4,80	0,191	0,440				
2400	4,70	0,187	0,470				

Rotational speeds over 20000 rpm and/or belt speeds over 80 m/s need special drive designs. Please ask for our advice.

## 2. Tension member strength (permitted tensile force of the belt F<sub>zul</sub>), Belt weight

Belt width	b	[mm]	4	6	10	16	25	32
Tension member strength F <sub>zul</sub>		[N]	39	65	117	195	312	403
Belt weight	T 2,5	[kg/m]	0,006	0,009	0,015	0,024	0,038	0,048
	T 2,5-DL	[kg/m]	0,006	0,009	0,016	0,025	0,040	0,051

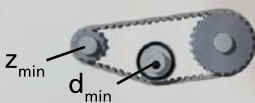
## 3. Flexibility (Minimum numbers of teeth, minimum diameter)

Timing pulley	Z <sub>min</sub>	10		Drive type without contraflexure
Tension roller (smooth), running on teeth	d <sub>min</sub> [mm]	15		
Timing pulley	Z <sub>min</sub>	18		Drive type with contraflexure
Tension roller (smooth), running on the back of the belt	d <sub>min</sub> [mm]	15		

# T standard Timing Belts

## T 5 / T 5-DL

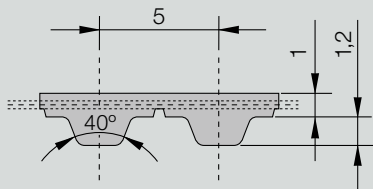

CONTI® SYNCHROFLEX Timing Belt (SFX) T 5

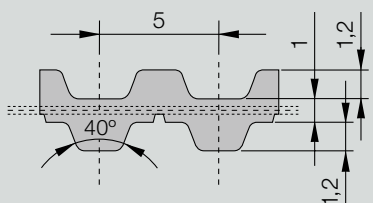

CONTI® SYNCHROFLEX Timing Belt (SFX) T 5-DL

Standard T profile according to DIN 7721 with metric pitch and trapezoidal teeth.

The technical data refer to standard polyurethane and standard steel cord tension members.

**Available versions:**

- single-sided (as standard)
- with "E" tension member for a better flexibility
- with Aramide tension member
- polyurethane special materials upon request
- antistatic, coloured, mechanical reworked

**DL:** double-sided

**FA:** with bigger back thickness

**FN:** with profiles on the back of the belt

**Order example**

CONTI® SYNCHROFLEX Timing Belt 10 T5/455

Belt width in mm \_\_\_\_\_

Type/Pitch \_\_\_\_\_

Belt length in mm \_\_\_\_\_

Type / Length*	Number of teeth	Type / Length*	Number
T 5 / 100	20	T 5 / 590 DL	118
T 5 / 150	30	T 5 / 600 FN	120
T 5 / 150 DL	30	T 5 / 610	122
T 5 / 165	33	T 5 / 615 FN	123
T 5 / 165 FN33	33	T 5 / 620	124
T 5 / 180	36	T 5 / 620 DL	124
T 5 / 185	37	T 5 / 625 DL	125
T 5 / 200	40	T 5 / 630	126
T 5 / 210	42	T 5 / 630 FA	126
T 5 / 215	43	T 5 / 650	130
T 5 / 220	44	T 5 / 650 FA	130
T 5 / 225	45	T 5 / 660	132
T 5 / 225 FN90	45	T 5 / 660 FN30	132
T 5 / 245	49	T 5 / 690	138
T 5 / 250	50	T 5 / 690 FA	138
T 5 / 255	51	T 5 / 690 FN3	138
T 5 / 260	52	T 5 / 700	140
T 5 / 260 DL	52	T 5 / 720	144
T 5 / 260 FN1	52	T 5 / 725	145
T 5 / 270	54	T 5 / 750	150
T 5 / 280	56	T 5 / 750 DL	150
T 5 / 295	59	T 5 / 765	153
T 5 / 300 DL	60	T 5 / 780	156
T 5 / 305	61	T 5 / 800	160
T 5 / 330	66	T 5 / 800 FN2	160
T 5 / 330 DL	66	T 5 / 815	163
T 5 / 340	68	T 5 / 815 DL	163
T 5 / 340 FN6	68	T 5 / 840	168
T 5 / 355	71	T 5 / 840 FN	168
T 5 / 365	73	T 5 / 860 FN1	172
T 5 / 390	78	T 5 / 860 DL	172
T 5 / 390 FN1	78	T 5 / 900	180
T 5 / 400	80	T 5 / 920	184
T 5 / 410	82	T 5 / 925	185
T 5 / 410 DL	82	T 5 / 925 FN1	185
T 5 / 420	84	T 5 / 940	188
T 5 / 455	91	T 5 / 940 DL	188
T 5 / 460	92	T 5 / 990	198
T 5 / 460 FN4	92	T 5 / 990 FN4	198
T 5 / 460 DL	92	T 5 / 1075	215
T 5 / 480	96	T 5 / 1075 FA	215
T 5 / 500	100	T 5 / 1100	220
T 5 / 500 FN10	100	T 5 / 1100 DL	220
T 5 / 505	101	T 5 / 1100 FN22	220
T 5 / 510	102	T 5 / 1140 FN1	228
T 5 / 510 FN1	102	T 5 / 1160	232
T 5 / 515 DL	103	T 5 / 1215	243
T 5 / 525	105	T 5 / 1215 FN	243
T 5 / 525 FA	105	T 5 / 1315	263
T 5 / 525 DL	105	T 5 / 1325 DL	265
T 5 / 545	109	T 5 / 1350 FN1	270
T 5 / 550	110	T 5 / 1380	276
T 5 / 560	112	T 5 / 1380 FN1	276
T 5 / 575	115	T 5 / 1500	300
T 5 / 590	118		

Preferred belt width\* in mm:  
6, 10, 16, 25, 50

\* Other dimensions upon request.

# T 5 / T 5-DL Technical data

## 1. Tooth shear strength (specific belt tooth strength)



R.p.m. n [min <sup>-1</sup> ]	F <sub>Uspec</sub> [N/cm]	M <sub>spec</sub> [Ncm/cm]	P <sub>spec</sub> [W/cm]	R.p.m. n [min <sup>-1</sup> ]	F <sub>Uspec</sub> [N/cm]	M <sub>spec</sub> [Ncm/cm]	P <sub>spec</sub> [W/cm]
0	24,00	1,910	0,000	2000	13,69	1,089	2,28
20	23,40	1,861	0,039	2200	13,38	1,065	2,45
40	22,90	1,819	0,076	2400	13,10	1,042	2,62
60	22,40	1,783	0,112	2600	12,84	1,021	2,78
80	22,00	1,751	0,147	2800	12,59	1,002	2,94
100	21,70	1,723	0,180	3000	12,37	0,984	3,09
200	20,30	1,614	0,338	3200	12,16	0,967	3,24
300	19,30	1,536	0,483	3400	11,96	0,951	3,39
400	18,55	1,476	0,618	3600	11,77	0,936	3,53
500	17,93	1,427	0,747	3800	11,59	0,922	3,67
600	17,41	1,385	0,870	4000	11,42	0,909	3,81
700	16,96	1,349	0,989	4500	11,03	0,878	4,14
800	16,56	1,318	1,104	5000	10,68	0,850	4,45
900	16,20	1,289	1,215	5500	10,36	0,825	4,75
1000	15,88	1,263	1,323	6000	10,07	0,802	5,04
1100	15,58	1,240	1,428	6500	9,81	0,780	5,31
1200	15,31	1,218	1,531	7000	9,56	0,761	5,58
1300	15,06	1,198	1,632	7500	9,33	0,742	5,83
1400	14,83	1,180	1,730	8000	9,11	0,725	6,08
1500	14,61	1,162	1,826	8500	8,91	0,709	6,31
1600	14,40	1,146	1,920	9000	8,72	0,694	6,54
1700	14,21	1,131	2,010	9500	8,54	0,679	6,76
1800	14,03	1,116	2,100	10000	8,37	0,666	6,97
1900	13,85	1,102	2,190				

Rotational speeds over 10000 rpm and/or belt speeds over 80 m/s need special drive designs. Please ask for our advice.

## 2. Tension member strength (permitted tensile force of the belt F<sub>zul</sub>), Belt weight

Belt width	b	[mm]	6	10	16	25	32	50	75	100
Tension member strength F <sub>zul</sub>		[N]	180	330	570	930	1200	1920	2940	3930
Belt weight	T 5	[kg/m]	0,014	0,024	0,038	0,060	0,077	0,120	0,180	0,240
	T 5-DL	[kg/m]	0,016	0,027	0,043	0,067	0,086	0,135	0,203	0,270

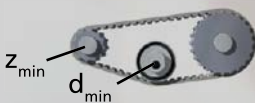
## 3. Flexibility (Minimum numbers of teeth, minimum diameter)

Timing pulley	Z <sub>min</sub>	10		Drive type without contraflexure
Tension roller (smooth), running on teeth	d <sub>min</sub> [mm]	30		
Timing pulley	Z <sub>min</sub>	15		Drive type with contraflexure
Tension roller (smooth), running on the back of the belt	d <sub>min</sub> [mm]	30		

# T standard Timing Belts

## T 10 / T 10-DL

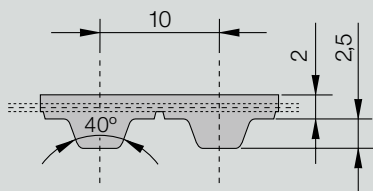

CONTI® SYNCHROFLEX Timing Belt (SFX) T 10

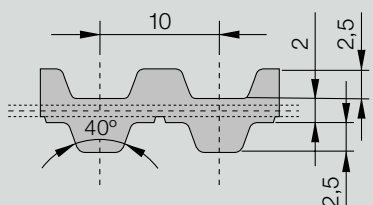

CONTI® SYNCHROFLEX Timing Belt T (SFX) 10-DL

Standard T profile according to DIN 7721 with metric pitch and trapezoidal teeth.

The technical data refer to standard polyurethane and standard steel cord tension members.

**Available version**

- single-sided (as standard)
- with "E" tension member for a better flexibility
- with Aramide tension member
- polyurethane special materials upon request
- antistatic, coloured, mechanical reworked

**DL:** double-sided

**FA:** with bigger back thickness

**FN:** with profiles on the back of the belt

**Order example**

CONTI® SYNCHROFLEX Timing Belt 16 T10/260

Belt width in mm \_\_\_\_\_

Type/Pitch \_\_\_\_\_

Belt length in mm \_\_\_\_\_

Type / Length*	Number of teeth	Type / Length*	Number of teeth
T 10 / 260	26	T 10 / 980	98
T 10 / 260 DL	26	T 10 / 980 DL	98
T 10 / 350	35	T 10 / 1010	101
T 10 / 370	37	T 10 / 1080	108
T 10 / 400	40	T 10 / 1110	111
T 10 / 410	41	T 10 / 1140	114
T 10 / 410 FA	41	T 10 / 1150	115
T 10 / 420 FN21	42	T 10 / 1210	121
T 10 / 440	44	T 10 / 1210 DL	121
T 10 / 450	45	T 10 / 1240	124
T 10 / 500	50	T 10 / 1240 DL	124
T 10 / 500 FN	50	T 10 / 1250	125
T 10 / 530	53	T 10 / 1250 DL	125
T 10 / 530 DL	53	T 10 / 1300	130
T 10 / 560	56	T 10 / 1320	132
T 10 / 600	60	T 10 / 1320 DL	132
T 10 / 610	61	T 10 / 1350	135
T 10 / 630	63	T 10 / 1350 DL	135
T 10 / 630 DL	63	T 10 / 1390	139
T 10 / 660	66	T 10 / 1400	140
T 10 / 660 DL	66	T 10 / 1420	142
T 10 / 680	68	T 10 / 1420 DL	142
T 10 / 690	69	T 10 / 1450	145
T 10 / 700	70	T 10 / 1460	146
T 10 / 720	72	T 10 / 1460 FN146	146
T 10 / 720 DL	72	T 10 / 1500	150
T 10 / 730	73	T 10 / 1560	156
T 10 / 750	75	T 10 / 1610	161
T 10 / 760	76	T 10 / 1610 DL	161
T 10 / 780	78	T 10 / 1750	175
T 10 / 780 FN78	78	T 10 / 1780	178
T 10 / 800 FN80	80	T 10 / 1800 FN12	180
T 10 / 810	81	T 10 / 1880	188
T 10 / 840	84	T 10 / 1880 DL	188
T 10 / 840 DL	84	T 10 / 1960	196
T 10 / 840 FN84	84	T 10 / 2250	225
T 10 / 850	85	T 10 / 3100	310
T 10 / 880	88	T 10 / 4780	478
T 10 / 890	89	T 10 / 4780 DL**	478
T 10 / 920	92		
T 10 / 960	96		
T 10 / 970	97		
T 10 / 970 FN97	97		

Preferred belt width\* in mm:  
16, 25, 32, 50

\* Other dimensions upon request.  
\*\* Please request technical support from your Mulco sales partner.



# T 10 / T 10-DL Technical data

## 1. Tooth shear strength (specific belt tooth strength)



R.p.m. n [min <sup>-1</sup> ]	F <sub>Uspec</sub> [N/cm]	M <sub>spec</sub> [Ncm/cm]	P <sub>spec</sub> [W/cm]	R.p.m. n [min <sup>-1</sup> ]	F <sub>Uspec</sub> [N/cm]	M <sub>spec</sub> [Ncm/cm]	P <sub>spec</sub> [W/cm]
0	50,5	8,04	0,000	2000	25,40	4,04	8,46
20	49,0	7,80	0,163	2200	24,60	3,92	9,03
40	47,7	7,60	0,318	2400	23,90	3,81	9,58
60	46,6	7,42	0,466	2600	23,30	3,71	10,10
80	45,7	7,27	0,609	2800	22,70	3,62	10,60
100	44,8	7,13	0,746	3000	22,20	3,53	11,08
200	41,4	6,60	1,381	3200	21,70	3,45	11,55
300	39,1	6,22	1,953	3400	21,20	3,36	11,99
400	37,2	5,92	2,480	3600	20,70	3,30	12,42
500	35,7	5,68	2,980	3800	20,30	3,23	12,84
600	34,4	5,48	3,440	4000	19,86	3,16	13,24
700	33,3	5,31	3,890	4500	18,91	3,01	14,18
800	32,4	5,15	4,320	5000	18,06	2,87	15,05
900	31,5	5,01	4,730	5500	17,28	2,75	15,84
1000	30,7	4,89	5,120	6000	16,58	2,64	16,58
1100	30,0	4,77	5,500	6500	15,93	2,54	17,26
1200	29,3	4,67	5,870	7000	15,33	2,44	17,88
1300	28,7	4,57	6,220	7500	14,76	2,35	18,46
1400	28,2	4,48	6,570	8000	14,24	2,27	18,99
1500	27,6	4,40	6,910	8500	13,74	2,18	19,47
1600	27,1	4,32	7,230	9000	13,28	2,11	19,92
1700	26,7	4,24	7,550	9500	12,84	2,04	20,30
1800	26,2	4,17	7,860	10000	12,42	1,97	20,70
1900	25,8	4,10	8,160				

Rotational speeds over 10000 rpm and/or belt speeds over 60 m/s need special drive designs. Please ask for our advice.

## 2. Tension member strength (permitted tensile force of the belt F<sub>zul</sub>), Belt weight

Belt width	b	[mm]	16	25	32	50	75	100	150
Tension member strength F <sub>zul</sub>		[N]	1200	2000	2700	4300	6600	8800	13400
Belt weight	T 10	[kg/m]	0,077	0,120	0,154	0,240	0,360	0,480	0,720
	T 10-DL	[kg/m]	0,091	0,143	0,182	0,285	0,428	0,570	0,855

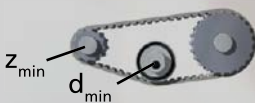
## 3. Flexibility (Minimum numbers of teeth, minimum diameter)

Timing pulley	z <sub>min</sub>	12		Drive type without contraflexure
Tension roller (smooth), running on teeth	d <sub>min</sub> [mm]	60		
Timing pulley	z <sub>min</sub>	20		Drive type with contraflexure
Tension roller (smooth), running on the back of the belt	d <sub>min</sub> [mm]	60		

# T standard Timing Belts

## T 20 / T 20-DL

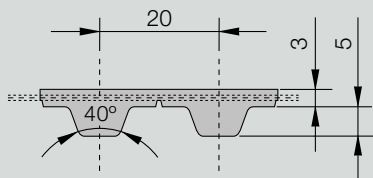

CONTI® SYNCHROFLEX Timing Belt (SFX) T 20

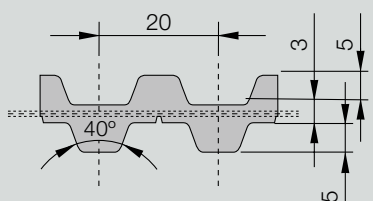

CONTI® SYNCHROFLEX Timing Belt (SFX) T 20-DL

Standard T profile according to DIN 7721 with metric pitch and trapezoidal teeth.

The technical data refer to standard polyurethane and standard steel cord tension members.

**Available versions:**

- single-sided (as standard)
- with "E" tension member for a better flexibility
- with Aramide tension member (except DL)
- polyurethane special materials upon request
- antistatic, coloured, mechanical reworked

**DL:** double-sided

Type / Length*	Number of teeth
T 20 / 1260	63
T 20 / 1460	73
T 20 / 1780	89
T 20 / 1880	94
T 20 / 2600	130

Type / Length*	Number of teeth
T 20 / 2600 DL**	130
T 20 / 3100	155
T 20 / 3620	181
T 20 / 3620 DL**	181

Preferred belt width\* in mm:  
32, 50, 75, 100

\* Other dimensions upon request.  
\*\* In combination with reduced pulley gap please ask for technical support from your Mulco sales partner.

**Order example**

CONTI® SYNCHROFLEX Timing Belt 50 T20/2600

Belt width in mm \_\_\_\_\_

Type/Pitch \_\_\_\_\_

Belt length in mm \_\_\_\_\_

# T 20 / T 20-DL Technical data

## 1. Tooth shear strength (specific belt tooth strength)

R.p.m. n [min <sup>-1</sup> ]	F <sub>Uspec</sub> [N/cm]	M <sub>spec</sub> [Ncm/cm]	P <sub>spec</sub> [W/cm]
0	101,5	32,30	0,000
20	98,1	31,20	0,654
40	95,3	30,30	1,271
60	92,8	29,50	1,856
80	90,7	28,90	2,420
100	88,7	28,20	2,960
200	81,2	25,90	5,420
300	75,9	24,20	7,590
400	71,8	22,90	9,570
500	68,4	21,80	11,410
600	65,6	20,90	13,110
700	63,1	20,10	14,730
800	60,9	19,40	16,250
900	59,0	18,78	17,700
1000	57,2	18,22	19,080
1100	55,6	17,71	20,400
1200	54,2	17,24	21,700
1300	52,8	16,80	22,900
1400	51,5	16,40	24,000
1500	50,3	16,02	25,200
1600	49,2	15,66	26,200
1700	48,2	15,33	27,300
1800	47,2	15,01	28,300
1900	46,2	14,71	29,300



R.p.m. n [min <sup>-1</sup> ]	F <sub>Uspec</sub> [N/cm]	M <sub>spec</sub> [Ncm/cm]	P <sub>spec</sub> [W/cm]
2000	45,3	14,42	30,2
2200	43,6	13,89	32,0
2400	42,1	13,40	33,7
2600	40,7	12,95	35,2
2800	39,4	12,53	36,7
3000	38,1	12,13	38,1
3200	37,0	11,77	39,4
3400	35,9	11,42	40,7
3600	34,9	11,09	41,8
3800	33,9	10,78	42,9
4000	33,0	10,49	43,9
4500	30,8	9,81	46,2
5000	28,9	9,21	48,2
5500	27,2	8,66	49,9
6000	25,6	8,16	51,2
6500	24,2	7,69	52,4

Rotational speeds over 6500 rpm and/or belt speeds over 40 m/s need special drive designs. Please ask for our advice.

## 2. Tension member strength (permitted tensile force of the belt F<sub>zul</sub>), Belt weight

Belt width	b	[mm]	32	50	75	100	150
Tension member strength F <sub>zul</sub>	[N]		4750	7750	12000	16000	24500
Belt weight	T 20	[kg/m]	0,269	0,420	0,630	0,840	1,260
	T 20-DL	[kg/m]	0,355	0,555	0,833	1,110	1,665

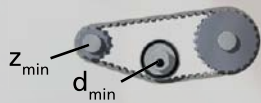
## 3. Flexibility (Minimum numbers of teeth, minimum diameter)

Timing pulley	Z <sub>min</sub>	15		Drive type without contraflexure
Tension roller (smooth), running on teeth	d <sub>min</sub> [mm]	120		
Timing pulley	Z <sub>min</sub>	25		Drive type with contraflexure
Tension roller (smooth), running on the back of the belt	d <sub>min</sub> [mm]	120		

# Imperial Timing Belts

## M (MXL)

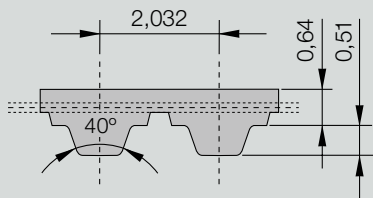

CONTI® SYNCHROFLEX Timing Belt (SFX) M (MXL)

Standard trapezoidal teeth according to DIN/ISO 5296 with Minipitch (2.032 mm = 0.08 Inch).

The technical data refer to standard polyurethane and standard steel cord tension members.

**Available versions:**

- single-sided
- with Aramide tension member
- polyurethane special materials upon request
- antistatic, coloured, mechanical reworked

**FA:** with bigger back thickness

**FN:** with profiles on the back of the belt

Type / Length*	Number of teeth	Type / Length*	Number of teeth
M 111 / 111,76	55	M 264 / 264,16	130
M 113 / 113,79	56	M 284 / 284,48	140
M 121 / 121,92	60	M 304 / 304,80	150
M 121 / 121,92 FA	60	M 355 / 355,60	175
M 132 / 132,08	65	M 373 / 373,89	184
M 142 / 142,24	70	M 449 / 449,07	221
M 144 / 144,27	71	M 503 / 503,94	248
M 162 / 162,56	80	M 508 / 508,00 FN	250
M 182 / 182,88	90	M 520 / 520,19	256
M 197 / 197,10	97	M 599 / 599,44	295
M 203 / 203,20	100	M 731 / 731,52	360
M 209 / 209,30	103	M1178 / 1178,56	580
M 213 / 213,36	105		
M 243 / 243,86	120		
M 256 / 256,03	126		

Preferred belt width\* in mm:  
4, 6, 10

\* Other dimensions upon request.

**Order example**

CONTI® SYNCHROFLEX Timing Belt 6 M / 182

Belt width in mm \_\_\_\_\_  
 Type/Pitch \_\_\_\_\_  
 Belt length in mm \_\_\_\_\_

# M (MXL) Technical data

## 1. Tooth shear strength (specific belt tooth strength)

R.p.m. n [min <sup>-1</sup> ]	F <sub>Uspec</sub> [N/cm]	M <sub>spec</sub> [Ncm/cm]	P <sub>spec</sub> [W/cm]	R.p.m. n [min <sup>-1</sup> ]	F <sub>Uspec</sub> [N/cm]	M <sub>spec</sub> [Ncm/cm]	P <sub>spec</sub> [W/cm]
0	6,58	0,209	0,000	2500	3,39	0,108	0,282
20	6,36	0,202	0,004	2600	3,35	0,107	0,290
40	6,18	0,197	0,008	2800	3,29	0,105	0,307
60	6,03	0,192	0,012	2880	3,26	0,104	0,313
80	5,90	0,188	0,016	3000	3,23	0,103	0,323
100	5,79	0,184	0,019	3200	3,17	0,101	0,338
150	5,56	0,177	0,028	3400	3,12	0,099	0,354
200	5,38	0,171	0,036	3600	3,07	0,098	0,368
300	5,10	0,162	0,051	3800	3,02	0,096	0,383
400	4,89	0,156	0,065	4000	2,98	0,095	0,397
500	4,72	0,150	0,079	4500	2,88	0,092	0,432
600	4,58	0,146	0,092	5000	2,78	0,088	0,463
700	4,45	0,142	0,104	5500	2,70	0,086	0,495
730	4,42	0,141	0,108	6000	2,63	0,084	0,526
800	4,35	0,138	0,116	6500	2,56	0,081	0,555
900	4,25	0,135	0,127	7000	2,49	0,079	0,581
1000	4,16	0,132	0,139	7500	2,43	0,077	0,607
1100	4,08	0,130	0,150	8000	2,37	0,075	0,632
1200	4,01	0,128	0,160	8500	2,32	0,074	0,657
1300	3,94	0,125	0,171	9000	2,27	0,072	0,681
1400	3,88	0,124	0,181	9500	2,22	0,071	0,703
1460	3,85	0,123	0,187	10000	2,18	0,069	0,727
1500	3,82	0,122	0,191	12000	2,02	0,064	0,808
1600	3,77	0,120	0,201	15000	1,82	0,058	0,910
1700	3,72	0,118	0,211	18000	1,66	0,053	0,996
1800	3,67	0,117	0,220	20000	1,57	0,050	1,047
1900	3,62	0,115	0,229				
2000	3,58	0,114	0,239				
2200	3,50	0,111	0,257				
2400	3,42	0,109	0,274				

Rotational speeds over 20000 rpm and/or belt speeds over 80 m/s need special drive designs. Please ask for our advice.

## 2. Tension member strength (permitted tensile force of the belt F<sub>zul</sub>), Belt weight

Belt width	b	[mm]	4	6	10	16	25	32
Tension member strength F <sub>zul</sub>		[N]	39	65	117	195	312	403
Belt weight	M	[kg/m]	0,005	0,007	0,012	0,019	0,030	0,038

## 3. Flexibility (Minimum numbers of teeth, minimum diameter)

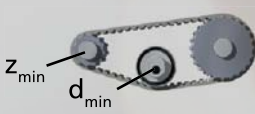
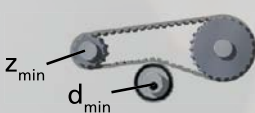
Timing pulley	z <sub>min</sub>	10		Drive type without contraflexure
Tension roller (smooth), running on teeth	d <sub>min</sub> [mm]	15		
Timing pulley	z <sub>min</sub>	18		Drive type with contraflexure
Tension roller (smooth), running on the back of the belt	d <sub>min</sub> [mm]	15		

# Serrated Profile Timing Belts

## K 1 / K 1,5

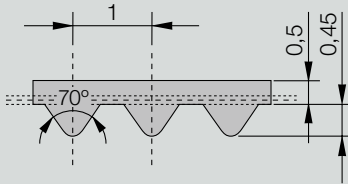

CONTI® SYNCHROFLEX Timing Belt (SFX) K 1

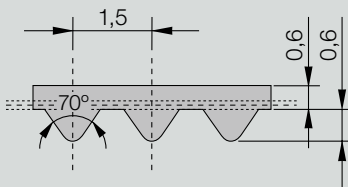

CONTI® SYNCHROFLEX Timing Belt (SFX) K 1,5

Serrated metric pitch profile.

The technical data refer to standard polyurethane and standard steel cord tension members.

**Available versions:**

- single-sided
- with Aramide tension member
- polyurethane special materials upon request
- antistatic, coloured, mechanical reworked

Type / Length*	Number of teeth	Type / Length*	Number of teeth
K 1 / 279,0	279	K 1,5 / 400,5 267 K 1,5 / 501,0 334 K 1,5 / 600,0 400 K 1,5 / 1242,5 828 K 1,5 / 1671,5 1114	
K 1 / 348,0	348		
K 1,5 / 57,0**	38		
K 1,5 / 64,5**	43		
K 1,5 / 67,5**	45		
K 1,5 / 100,5	67		
K 1,5 / 141,0	94		
K 1,5 / 165,0	110		
K 1,5 / 201,0	134		
K 1,5 / 228,0	152		
K 1,5 / 286,0	191		
K 1,5 / 300,0	200		

Preferred belt width\* in mm:  
4, 6, 10

\* Other dimensions upon request.  
\*\* In casting polyurethane 93 ShA, red colour.

**Order example**

CONTI® SYNCHROFLEX Timing Belt 6 K1,5/100,5

Belt width in mm \_\_\_\_\_

Type/Pitch \_\_\_\_\_

Belt length in mm \_\_\_\_\_



## K / K1,5 Technical data

### 1. Tooth shear strength (specific belt tooth strength)



R.p.m. n [min <sup>-1</sup> ]	F <sub>Uspec</sub> [N/cm]	M <sub>spec</sub> [Ncm/cm]	P <sub>spec</sub> [W/cm]	R.p.m. n [min <sup>-1</sup> ]	F <sub>Uspec</sub> [N/cm]	M <sub>spec</sub> [Ncm/cm]	P <sub>spec</sub> [W/cm]
0	6,45	0,154	0,000	2500	3,32	0,079	0,207
20	6,23	0,149	0,003	2600	3,29	0,079	0,214
40	6,06	0,145	0,006	2800	3,22	0,077	0,225
60	5,91	0,141	0,009	2880	3,20	0,076	0,230
80	5,79	0,138	0,012	3000	3,17	0,076	0,238
100	5,68	0,136	0,014	3200	3,11	0,074	0,249
150	5,46	0,130	0,020	3400	3,06	0,073	0,260
200	5,28	0,126	0,026	3600	3,01	0,072	0,271
300	5,00	0,119	0,037	3800	2,96	0,071	0,281
400	4,80	0,115	0,048	4000	2,92	0,070	0,292
500	4,63	0,111	0,058	4500	2,82	0,067	0,317
600	4,49	0,107	0,067	5000	2,73	0,065	0,341
700	4,37	0,104	0,076	5500	2,65	0,063	0,364
730	4,33	0,103	0,079	6000	2,57	0,061	0,385
800	4,26	0,102	0,085	6500	2,51	0,060	0,408
900	4,17	0,100	0,094	7000	2,44	0,058	0,427
1000	4,08	0,097	0,102	7500	2,38	0,057	0,446
1100	4,00	0,095	0,110	8000	2,33	0,056	0,466
1200	3,93	0,094	0,118	8500	2,27	0,054	0,482
1300	3,87	0,092	0,126	9000	2,22	0,053	0,499
1400	3,81	0,091	0,133	9500	2,18	0,052	0,518
1460	3,77	0,090	0,138	10000	2,13	0,051	0,532
1500	3,75	0,090	0,141	12000	1,98	0,047	0,594
1600	3,69	0,088	0,148	15000	1,78	0,042	0,667
1700	3,64	0,087	0,155	18000	1,63	0,039	0,733
1800	3,60	0,086	0,162	20000	1,54	0,037	0,770
1900	3,55	0,085	0,169				
2000	3,51	0,084	0,175				
2200	3,43	0,082	0,189				
2400	3,35	0,080	0,201				

Rotational speeds over 20000 rpm and/or belt speeds over 80 m/s need special drive designs. Please ask for our advice.

### 2. Tension member strength (permitted tensile force of the belt F<sub>zul</sub>), Belt weight

Belt width	b	[mm]	4	6	10	16	25	32
Tension member strength F <sub>zul</sub>		[N]	39	65	117	195	312	403
Belt weight	K 1	[kg/m]	0,0044	0,007	0,011	0,018	0,028	0,035
	K 1,5	[kg/m]	0,004	0,006	0,010	0,016	0,025	0,032

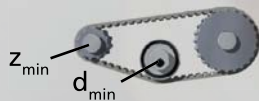
### 3. Flexibility (Minimum numbers of teeth, minimum diameter)

Timing pulley	z <sub>min</sub>	14		Drive type without contraflexure
Tension roller (smooth), running on teeth	d <sub>min</sub> [mm]	15		
Timing pulley	z <sub>min</sub>	20		Drive type with contraflexure
Tension roller (smooth), running on the back of the belt	d <sub>min</sub> [mm]	15		

# F Flat Belts

## F / AF / BF / CF / DF

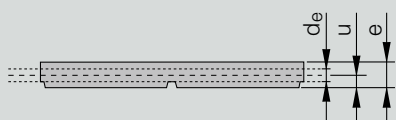

CONTI® SYNCHROFLEX Flat Belt (SFX)

The technical data refer to standard polyurethane and standard steel cord tension members.

Type	Mould Nr.	Length [mm]	e [mm]	u [mm]	d <sub>e</sub> [mm]
F 213/7	K3969-Z	212,95	1,60	0,800	0,15
F 254/4	K5111-Z	253,74	0,80	0,400	0,15
F 314/5	K5558-Z	314,16	5,50	2,000	0,60
F 315/4	K5428-Z	315,73	1,20	0,600	0,15
F 330/2	K5651-Z	330,00	1,00	0,400	0,15
F 435/2	K5691-Z	435,00	0,80	0,400	0,15
F 502/7	K5430-Z	501,84	1,00	0,500	0,30
F 697/4	52648-Z	695,57	0,55	0,275	0,15
F 738/4	K5112-Z	738,64	0,80	0,400	0,15
F 762/7	K3708-Z	762,00	2,60	1,300	0,30
F 959/2	K5578-Z	959,40	1,00	0,500	0,30
F 1240/10	K5178-Z	1240,00	1,20	0,800	0,60
F 1458/9	K4377-Z	1458,50	2,60	0,450	0,30
F 1780/10	K4667-Z	1780,00	1,40	0,600	0,60
AF 24	51669-Z	113,08	0,80	0,275	0,15
AF 56	51772-Z	263,16	0,80	0,400	0,15
AF 67	51601-Z	315,70	0,70	0,275	0,15
AF 76	39669-Z	357,30	0,80	0,400	0,15
AF 87	38919-Z	409,57	0,85	0,575	0,15
AF 108	39796-Z	508,39	0,70	0,275	0,15
AF 138	39847-Z	649,60	0,80	0,275	0,15
AF 140	40121-Z	659,03	0,60	0,275	0,15
AF 148	39631-Z	695,57	0,80	0,275	0,15
BF 44	38852-Z	345,57	0,90	0,450	0,30
BF 64	38805-Z	501,85	0,90	0,450	0,30
BF 67	38902-Z	525,70	0,90	0,450	0,30
BF 70	39980-Z	548,90	0,90	0,450	0,30
CF 66	38917-Z	828,55	1,40	0,700	0,60
DF 45	39839-Z	282,74	0,90	0,450	0,30
DF 130	51636-Z	815,34	0,90	0,450	0,30
DF 153	39979-Z	959,40	0,90	0,450	0,30

### Order example

CONTI® SYNCHROFLEX Flat Belt 10 AF/108

Belt width in mm

Type/No. of grooves

# Timing Belts with special tooth profiles

## V (excerpts of XL, L, H)

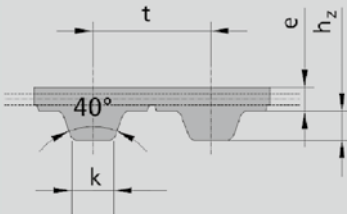

Type	Imperial pitch	Shape No.	Length l [mm]	Pitch t [mm]	Module m	Number of teeth		k [mm]	h <sub>z</sub> [mm]	e [mm]
						z				
V 177/5	F	XL	K5841-F	177,80	5,080	1,617	35	1,20	1,20	0,85
V 203/5	F	XL	K5369-F	203,20	5,080	1,617	40	1,37	1,27	0,80
V 233/5	F	XL	K5674-F	233,68	5,080	1,617	46	1,37	1,22	1,28
V 284/5	F	XL	K5445-F	284,48	5,080	1,617	56	1,80	1,20	0,70
V 304/5	F	XL	K5368-F	304,80	5,080	1,617	60	1,37	1,27	0,60
V 381/5	F	XL	K6026-F	381,00	5,080	1,617	75	1,35	1,25	0,95
V 406/5	F	XL	K6064-F	406,40	5,080	1,617	80	1,37	1,27	1,30
V 508/5	F	XL	K6011-F	508,00	5,080	1,617	100	1,32	1,22	1,32
V 609/5	F	XL	K5546-F	609,60	5,080	1,617	120	1,36	1,20	0,70
V 635/5	F	XL	K5394-F	635,00	5,050	1,617	125	1,32	1,20	0,60
V 685/5	F	XL	K5821-F	685,80	9,538	1,617	135	1,62	1,20	0,70
V 889/5	F	XL	K5601-F	889,00	5,050	1,617	175	1,80	1,20	1,00
V 1097/5	F	XL	K5993-F	1097,28	5,080	1,617	216	1,37	1,27	1,30
V 1102/5	F	XL	K5776-F	1102,36	5,080	1,617	217	1,80	1,20	1,20
V 1178/5	F	XL	K5876-F	1178,56	5,080	1,617	232	1,80	1,20	1,00
V 1584/5	F	XL	K5600-F	1584,96	5,080	1,617	312	1,80	1,20	1,00
V 438/9	F	L	K5095-F	438,15	9,525	3,032	46	3,20	1,80	1,00
V 571/9	F	L	K6114-F	571,50	9,525	3,032	60	3,26	1,91	1,69
V 971/9	F	L	K5354-F	971,55	9,525	3,032	102	3,25	1,90	1,40
V 990/9	F	L	K5185-F	990,60	9,525	3,032	104	3,10	2,20	1,65
V 1000/9	F	L	K5202-F	1000,13	9,525	3,032	105	3,10	2,20	1,65
V 1028/9	F	L	K5589-F	1028,70	9,525	3,032	108	3,10	1,90	1,65
V 1104/9	F	L	K5435-F	1104,90	9,525	3,032	116	3,25	1,90	2,30
V 1152/9	F	L	K5493-F	1152,53	9,525	3,032	121	3,10	1,90	1,65
V 1257/9	F	L	K5310-F	1257,30	9,525	3,032	132	3,20	1,90	1,65
V 1390/9	F	L	K5449-F	1390,65	9,525	3,032	146	3,20	1,90	1,30
V 914/12	F	H	K5692-F	914,40	12,700	4,043	72	4,30	2,20	1,85
V 1270/12	F	H	K5258-F	1270,00	12,700	4,043	100	4,45	2,18	2,01
V 1778/12	F	H	K5260-F	1778,00	12,700	4,043	140	4,40	2,30	1,40

### Order example

CONTI® SYNCHROFLEX Flat Belt 10 V 177 / 5 F

Belt width in mm

Type/Length

## Coated timing belts

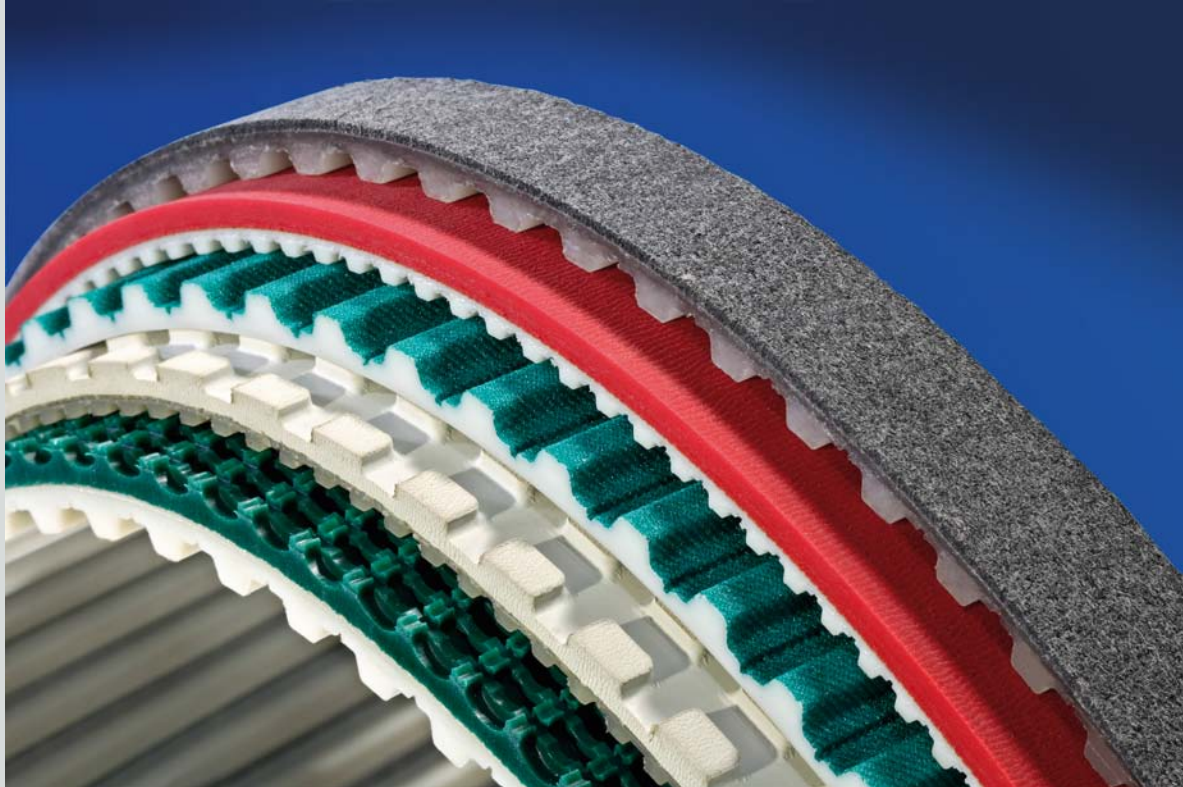

CONTI® SYNCHROFLEX Timing Belts consist of wear resistant polyurethane (PUR) and high tensile steel cord tension members. The coating of the timing belts with various materials provides a variety of application possibilities in the transport technology.

The selection of the correct coating depends on the transport item properties and the required grip. High friction for a good carrying effect, low friction to reduce the power transmission performance, soft for sensitive items or hard for sharp-edged items are the determining factors.

Every material involved assumes its task according to its specific property.

To meet specific transport applications, the tooth side and/or the transport side can be mechanically reworked. In this manner, the flexibility of the entire belt can be restored by making incisions in thick coatings.

### Resistance

Depending on the application the resistance of each material part of the coated timing belt is to be viewed separately. The material resistance depends, among others, on the pH value, the concentration, the temperature and the influencing time of the medium. Simple oils generally have no damaging effect on the belt. Additives in the oil and temperatures over approx. 40°C can reduce the longevity.

### Friction

The friction of the belt on a support produces heat. This increases the more the belt is loaded by the items to be transported. The bed support must be selected such that the friction value of the transport belt in contact with the material of the bed plate results in a minimum value. The bed plate should guarantee good heat dissipation under high pressure forces.

The friction value is temperature dependent. It increases as the temperature rises and reduces at temperatures below zero (frost).

### Information

You should ask for advice for coatings over 75 mm wide and approx. 2 mm thick because of the different processing properties.

### Drives with contraflexure

Generally, coated timing belts are suitable for drives with contraflexure. Very smooth coatings (e.g. Sylomer) must be adjusted with reduced pre-tension.

### Temperature influence

If hot items (above approx. 80°C) are transported, ensure that the contact time is as short as possible to avoid heating of the belt substructure to over 80°C. A coated belt can resist a thermally higher load over short distances or a short period, assuming that there being sufficient cooling for the remainder of the revolution.

The tooth shear strength is slightly reduced in a temperature range of over approx. 60°C. An additional safety factor is only required with a high tooth load.

The flexibility of the coating is reduced with low ambient temperatures. To this effect, select larger timing pulley diameters compared to normal temperatures (see diagram). The flexibility of the timing belt is also reduced with low temperatures.

The stated minimum diameters are standard values. They are valid with the ambient temperature of 20°C and a speed of 1m/s. A low load of the goods to be transported is presumed. Reducing the diameters is possible with precise knowledge of the application. Relevant advice can be obtained from your Mulco partner.

**Synchronising pulley diameter depending on the temperature**

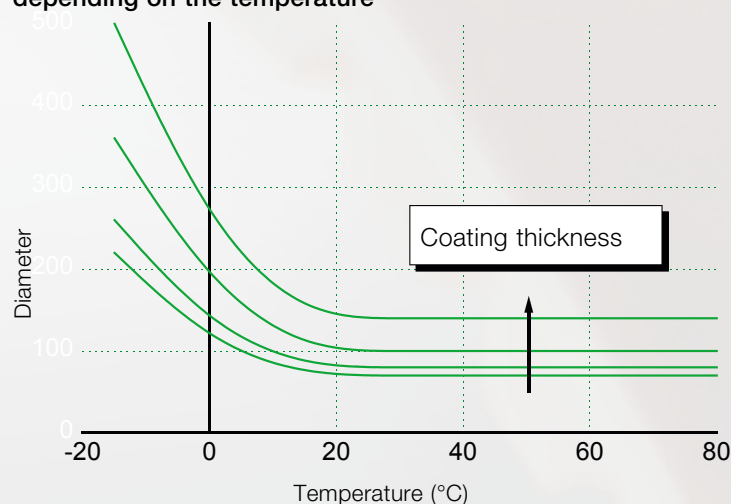



# Coated timing belts

## NP 385

Material designation: polyurethane  
 Colour: transparent  
 Hardness: 85 Shore A  
 Available thickness: 4 mm  
 Minimum diameter: 120 mm  
 Temperature resistance: -20°C to +50°C  
 Resistances: resistant against simple oils and fats  
 Properties: nub tip contact with the product to be transported  
 Application fields: transport with oil influence, sheet transport, elevator, brick making, glass industry



## FG 385

Material designation: polyurethane  
 Colour: transparent  
 Hardness: 85 Shore A  
 Available thickness: 4 mm  
 Minimum diameter: 120 mm  
 Temperature resistance: -20°C to +50°C  
 Resistances: resistant against simple oils and fats  
 Properties: linear contact of the product to be transported  
 Application fields: transport with oil influence, sheet transport, elevator, brick making, glass industry

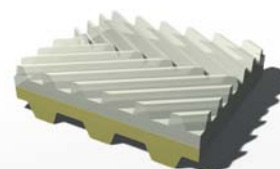

## PUR 385

Material designation: polyurethane  
 Colour: transparent  
 Hardness: 85 Shore A  
 Available thickness: 3      4      5      6    mm  
 Minimum diameter: 80     120    150    180 mm  
 Temperature resistance: -20°C to +50°C  
 Resistances: resistant to petrol, ozone, simple fats and oils  
 Properties: high resistance to wear, high coefficient of friction  
 Application fields: transport of parts showing a coarse surface or burrs, woodworking and sheet fabricating industry, glass industry, cardboard transport

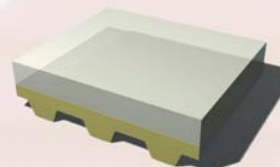



**HV1 film**

Material designation:	polyurethane
Colour:	transparent, shiny
Hardness:	88 Shore A
Available thickness:	1 mm
Minimum diameter:	60 mm
Melting range:	approx. 166°C
Resistances:	resistant to some cleaning agents
Properties:	good wear resistance, adhesive
Application fields:	foodstuff industry, glass and woodworking industry, sheet fabricating industry, cardboard transport

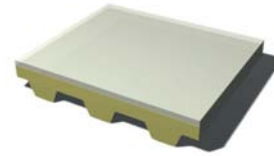
**Polythane D15**

Material designation:	polyurethane
Colour:	transparent/yellowish
Hardness:	70 Shore A
Available thickness:	2 3 to 6 mm
Minimum diameter:	60 80 mm
Temperature resistance:	80°C
Resistances:	resistant against simple oils and fats
Properties:	wear resistant
Application fields:	general transport tasks, woodworking and glass industry, sheet fabricating industry

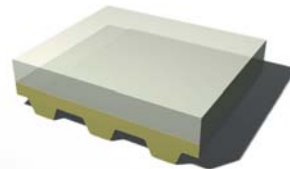
**Compound coating**

Material designation:	e.g. PUR/silicone
Colour:	white
Hardness:	60 / 50 Shore A
Available thickness:	2.4 mm
Minimum diameter:	60 mm
Temperature resistance:	in accordance with the materials used, Silicone: short-term 180°C
Resistances:	in accordance with the materials used
Properties:	non-stick
Application fields:	light weight transport tasks, air filter transport, textile and wood industry

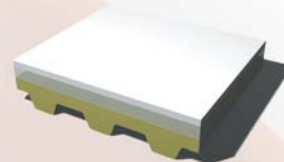
**PVC white**

Material designation:	PVC
Colour:	white
Hardness:	approx. 40 Shore A
Available thickness:	2 mm (more thicknesses on request)
Minimum diameter:	60 mm
Temperature resistance:	-15°C to +90°C
Resistances:	top covering layer is resistant against acid, salts and bases
Properties:	FDA approval for contact with foodstuff
Application fields:	foodstuff industry, film processing, pharmaceutical and packaging industry

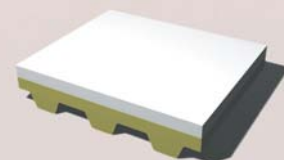

# Coated timing belts

## PU yellow

Material designation:	polyurethane										
Colour:	yellow										
Hardness:	approx. 55 ± 7 Shore A										
Available thickness:	2	3	4	5	6	8	10	mm			
Minimum diameter:	60	60	80	100	100	100	20	mm			
Temperature resistance:	-10°C to +60°C										
Resistances:	resistant against simple oils and fats										
Properties:	good wear resistance, very good to rework										
Application fields:	vacuum transport belts subject to high loads, paper industry, textile industry, glass and wood industry										

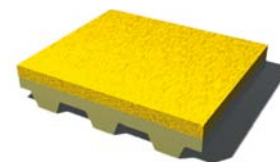

## Porol

Material designation:	cellular rubber									
Colour:	black									
Density, hardness:	190 g/dm <sup>3</sup> , approx. 15 Shore A									
Available thickness:	3	5	10 mm							
Minimum diameter:	40	60	80 mm							
Temperature resistance:	-40°C to +70°C									
Resistances:	resistance to some simple fats and oils									
Properties:	smooth foam quality, high coefficient of friction									
Application fields:	transport of sensitive parts, paper industry, textile industry, cardboard transport									

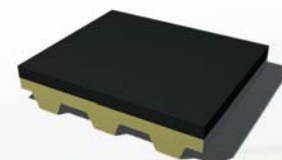

## Celloflex

Material designation:	microcellular elastomeric polyurethane									
Colour:	yellow-brown									
Density:	350 g/dm <sup>3</sup>									
Available thickness:	1	2	3	4	5 mm					
Minimum diameter:	40	40	60	60	80 mm					
Temperature resistance:	-30°C to +80°C									
Resistances:	resistance to some simple fats and oils									
Properties:	highly flexible, high damping ratio									
Application fields:	transport of sensitive items, film and packaging industry, textile transport									

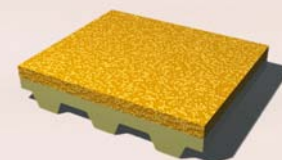

## Linatex

Material designation:	natural rubber									
Colour:	red									
Hardness:	approx. 40 Shore A									
Available thickness:	1.5	2.4	3	5	6.4	8	10	12	20 mm	
Minimum diameter:	40	60	80	80	100	100	120	120	150 mm	
Temperature resistance:	-40°C to +70°C									
Resistances:	resistant to some oils and abrasion when wet									
Properties:	wear resistant to a limited extent, high coefficient of friction, high resistance to rupture, is still flexible at lower temperatures, please request for advice for coating thicknesses over 2.4 mm									
Application fields:	transport or haul-off belts subject to high friction, wood, paper, textile industry, transport with a high acceleration									

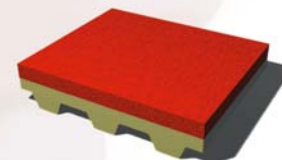

**Sylomer**

Material designation:	Elastomeric PUR		
Colour:	Blue (R)	Green (L)	Brown (M)
Density:	220	300	400 g/dm <sup>3</sup>
Available thickness:	3-25	3-25	3-25 mm
Minimum diameter:	80 - 120	80 - 120	80 - 120 mm
Temperature resistance:	-30°C to +70°C		
Resistances:	resistance to some oils and fats		
Properties:	good wear resistance, not suitable for sharpedged items		
Application fields:	transport of light weight parts, paper and textile industry, haul-off belts, pressure belts		

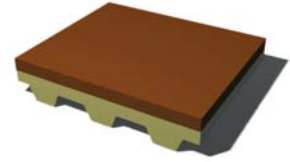
**PVC blue**

Material designation:	PVC
Colour:	blue
Hardness:	approx. 40 Shore A
Available thickness:	1 mm
Minimum diameter:	30 mm
Temperature resistance:	-15°C to +90°C
Resistances:	top covering layer is resistant against acid, salts and bases
Properties:	high coefficient of friction
Application fields:	paper, film, wood and sheet transport, pharmaceutic and packaging industry, application in card reading units

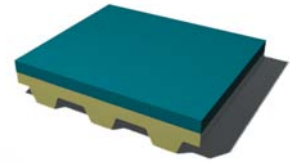
**Chrome-leather**

Material designation:	leather
Colour:	grey-blue
Hardness:	-
Available thickness:	2 3 mm
Minimum diameter:	80 100 mm
Temperature resistance:	60°C
Resistances:	resistant against simple oils and fats
Properties:	good friction even with oiled surfaces of items to be transported, good wear resistance behaviour
Application fields:	transport of fatty or oily parts, sheet and tube industry, transport of sensitive products, caterpillar haul-offs in the cable industry, transport of lacquered parts

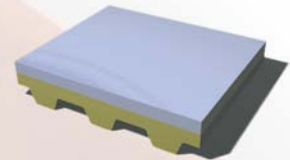
**Correx**

Material designation:	para rubber
Colour:	brown
Hardness:	approx. 35 to 40 shore A
Available thickness:	6 10 mm
Minimum diameter:	80 120 mm
Temperature resistance:	up to approx. 70°C
Resistances:	resistant to some oils and fats
Properties:	wear resistant quality, good carrying behaviour
Application fields:	general transport tasks, sheet and tube transport, cardboard transport

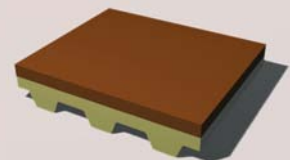

# Coated timing belts

## PVC herringbone

Material designation: PVC  
 Colour: white  
 Hardness: approx. 65 Shore A  
 Available thickness: 3 mm  
 Minimum diameter: 60 mm  
 Temperature resistance: -10°C to +110°C  
 Resistances: resistant to some oils and fats  
 Properties: FDA approval for contact with foodstuff  
 Application fields: foodstuff industry, elevators, transport of glass in wet areas

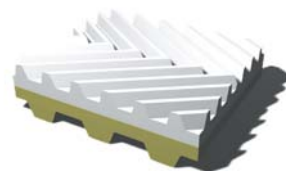

## Viton

Material designation: FKM mix  
 Colour: black  
 Hardness: 75 ± 5 Shore A  
 Available thickness: 2 4 mm  
 Minimum diameter: 80 100 mm  
 Temperature resistance: -10°C to +275°C  
 Resistances: high heat resistance, resistant against simple oils and fats, petrol, acids, lyes, ozone  
 Application fields: short-term transport of parts with high residual heat, belts with glue and adhesive contact, metal part and glass transport

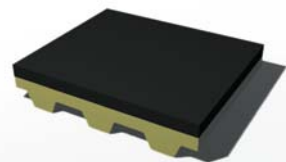

## Linatril

Material designation: vulcanized material based on nitrile  
 Colour: orange  
 Hardness: 55 Shore A  
 Available thickness: 3-6 mm (more thicknesses on request, max. 25 mm)  
 Minimum diameter: depending on the selected thickness, the thicker the coating the larger the diameter must be selected  
 Temperature resistance: -20°C to +110°C  
 Resistances: resistant against oil, fat and other chemicals  
 Properties: good wear resistance, ageing stability, fatigue resisting  
 Application fields: haul-off belts in the textile area, transport of waxy materials

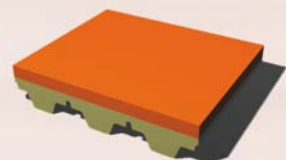

## Supergrip green/blue

Material designation:	PVC	
Colour:	green	blue
Hardness:	approx. 40 Shore A	approx. 40 Shore A
Available thickness:	4 mm	4 mm
Minimum diameter:	60 mm	60 mm
Temperature resistance:	-15°C to +90°C	-15°C to + 90°C
Resistances:	resistant against simple oils and fats	not resistant to oil
Properties:	high resistance to wear, high coefficient of friction	
Application fields:	particularly suitable for inclined conveying, transport of light weight items, elevators in the wood and paper industry	

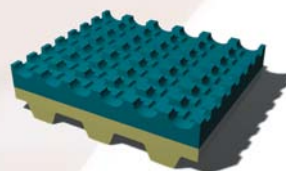

**RP 400**

Material designation:	rubber
Colour:	yellow
Hardness:	35 Shore A
Available thickness:	2 3 4 5 6 mm (more thicknesses on request, max. 30 mm)
Minimum diameter:	30 40 40 60 60 mm
Temperature resistance:	-10°C to +80°C
Resistances:	resistant to some oils and fats
Properties:	very high resistance against wear and tear
Application fields:	glass and steel industry, abrasive material up to a size of 40 mm

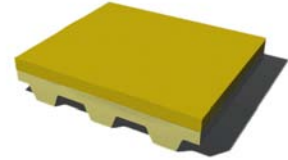
**NBR**

Material designation:	Nitrile Butadiene Rubber
Colour:	black
Hardness:	65 ± 5 Shore A
Available thickness:	1,5 3 mm
Minimum diameter:	60 80 mm
Temperature resistance:	-20°C to +70°C
Resistances:	well resistant against oils, resistant to a limit extent against petrol, acid and alkalis
Application fields:	general transport tasks

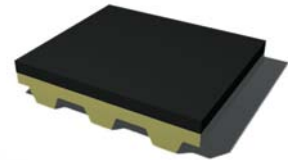
**PVC Minigrip**

Material designation:	PVC
Colour:	green/blue
Hardness:	approx. 65 Shore A
Available thickness:	1,5 mm
Minimum diameter:	30 mm
Temperature resistance:	-10°C to +110°C
Resistances:	resistant to some oils and fats
Properties:	high coefficient of friction
Application fields:	transport of damp parts, good carrying behaviour due to profiled surface

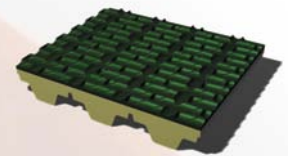
**TT 60**

Material designation:	polyester fleece
Colour:	black
Available thickness:	2 mm
Minimum diameter:	120 mm
Temperature resistance:	-10°C to +120°C
Resistances:	resistance to oils and fats
Properties:	electro-static properties
Application fields:	glass industry as transport belt in the hot area

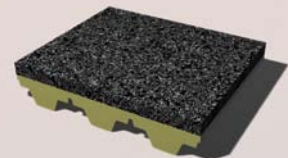



# Integrated flights

## CONTI® SYNCHROFLEX Timing Belts with cast flights/profiles:

CONTI® SYNCHROFLEX Timing Belts with profiles offer further opportunities for the designer with flights or cleats on the belt back. Can be used in conveying, feeding or positioning.

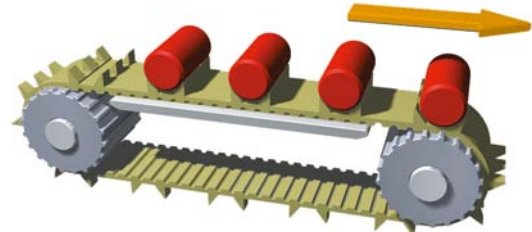

Assembly belt

Maximum precision is achieved by the manufacture in one operating step using a timing belt mould. Customer requirements with regard to the shape of the flights and

their number can be taken into consideration at the time of producing a new mould. Best flight centre distance tolerance achievable: +/- 0.05 mm.

### Examples of flighted CONTI® SYNCHROFLEX Timing Belts from a single mould:

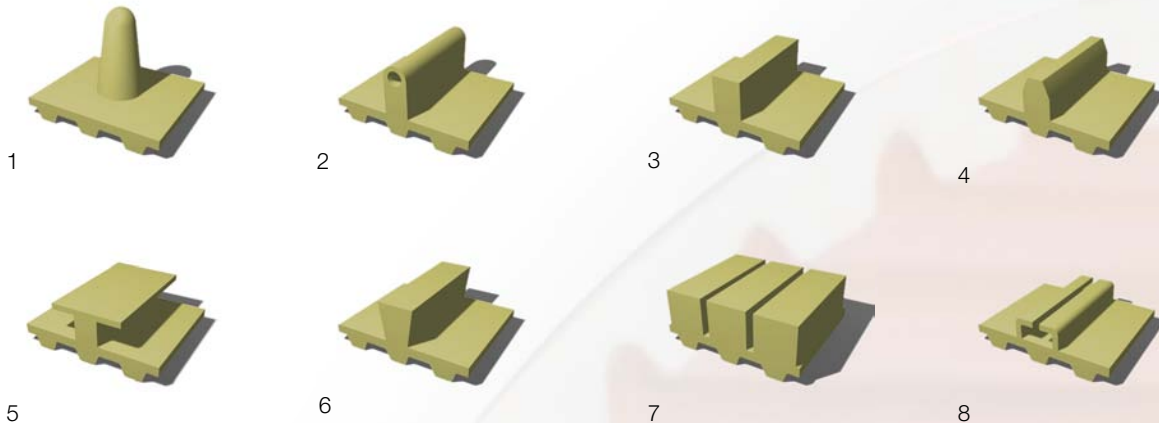

### Application example

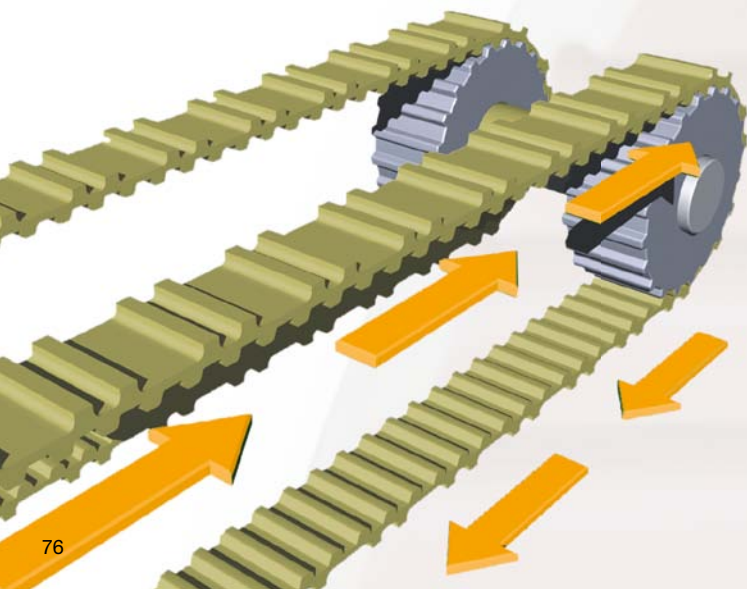

### Applications:

Synchronising technology to achieve maximum precision

- EDP equipment
- Office machinery
- Fine mechanical technology
- Packaging machinery
- Indexing systems
- Synchronous conveyors
- Handling technology
- Transport technology

Please contact us for technical advice if you require more detailed information on special belt dimensions (existing timing belt moulds).



**CONTI® SYNCHROFLEX Timing Belts  
with welded flights/profiles:**

All CONTI® SYNCHROFLEX Timing Belts as from pitch T 2.5 can be retrofitted with flights. In line with the customer's drawing, the desired number of flights are thermally butt-welded to the back of the belt. The achieve-

vable weld-on tolerance of each individual flight is  $\pm 0.5$  mm. Hundreds of shapes of flights are available. Please ask for additional information. For special customer requirements new flights can be manufactured.

**Examples of possible flight shapes requiring mechanical re-work:**

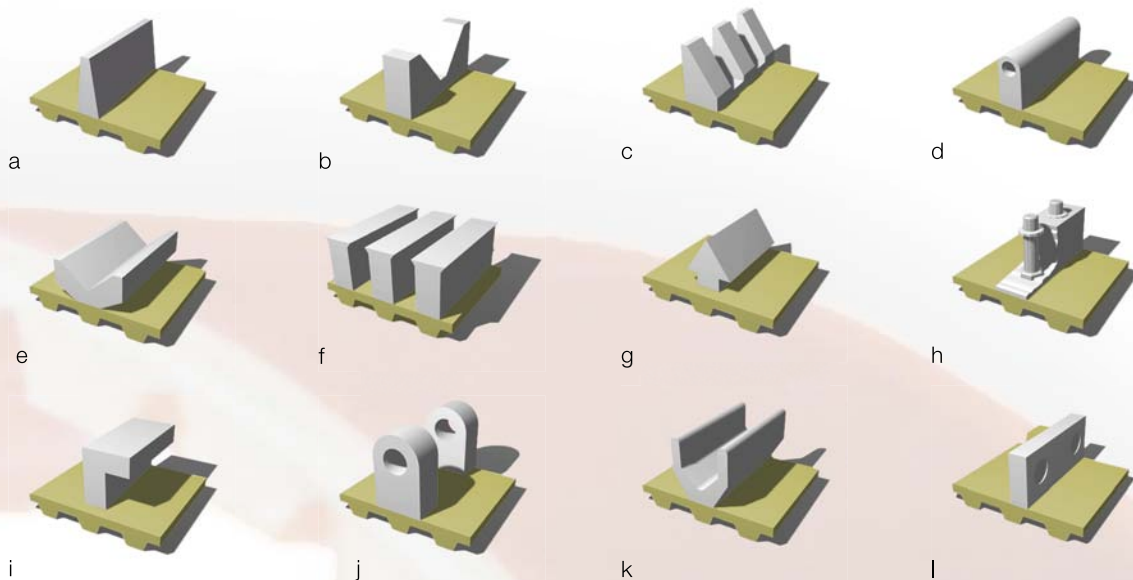

The various shapes of flights allow an adaptation of the transport timing belt to the envisaged practical function. The flight pitch is freely selectable. The flights can be manufactured with moulded inserts. Profile attachments can be retrofitted (positioned). The welding point itself and the maximum bending stress are subject to special parameters.

Please contact us for technical advice.

**Applications:**

General transport technology

- Conveying/transporting
- Separation
- Positioning
- Indexing
- Feeding

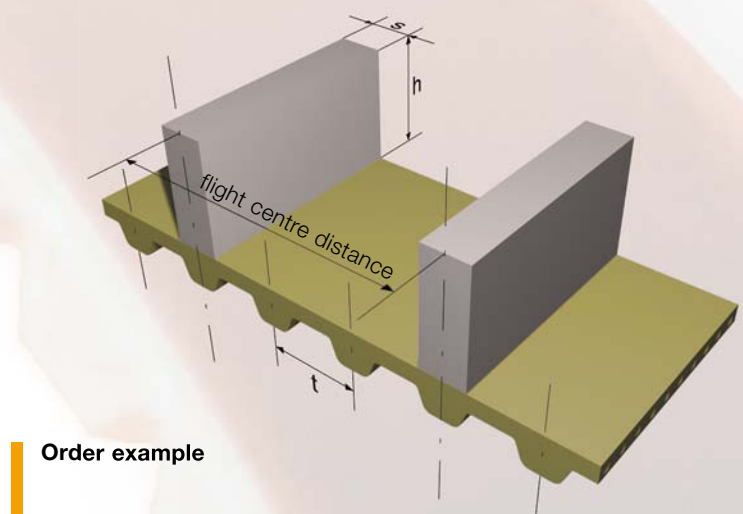

**Order example**

CONTI® SYNCHROFLEX Timing Belt	25 T 10 / 1960 - FN 49
Belt width in mm	_____
Type/Pitch	_____
Belt length in mm	_____
Number of profiles	_____

# Brush timing belts

## A solution for almost every application

To complement standard applications in power transmission, linear and transport technology, we offer the CONTI® SYNCHROFLEX Brush Timing Belt for special applications.

### Construction

The timing belt is either equipped with a stronger back with brush or - to meet the individual application - with brush flights. The thickness of the back is between 10 and 20 mm, depending on the fibre thickness and cutting length. Flight centre-distance, fibre density and type are individual matched to each application.

1. Timing belts with reinforced back (the necessary flexibility is achieved by notches in the back of the belt).
2. Brushes/fibres
3. Standard timing belt
4. Profile

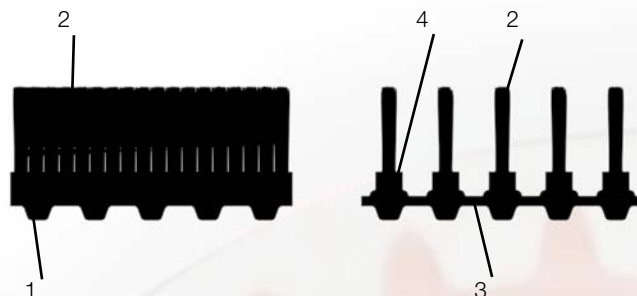

## Versatile application

### Conveying:

- Transport of sensitive parts for example: glass, ceramics, paper
- Conveying of materials featuring delicate surfaces
- Accumulation conveying due to the extremely low coefficient of friction
- Larger contact surface resulting from the fanned fibre arrangement
- Reduced conveying noise
- Dirt and chips cannot accumulate on the contact surface
- Combination with all transport flights

### Cleaning:

- Dry and wet application
- Surface treatment

### Product range

Brush timing belts are available in any length offered in our product range and in the following pitches:

T 5, T 10, T 20, AT 5, AT 10, AT 20

Please contact us for more detailed information on fibre materials, data on chemical resistances and admissible temperature ranges.

**Natural fibres and hair**

(max. cutting length 30 mm)

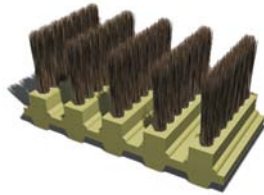

Horsehair, soft

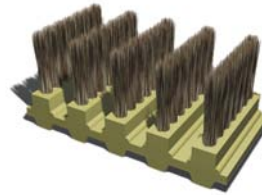

Horsehair mix, semi-hard

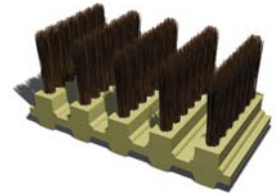
Calcutta bristles,  
semi-hard**Plant fibres**

(cutting length 10 to 75 mm)

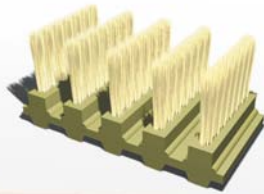

Mex. fibre, semi-hard

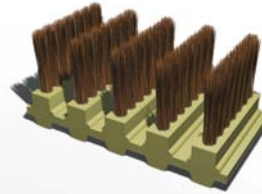

Arenga, hard

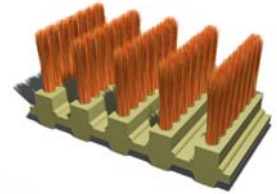

Coconut fibre, hard

**Artificial bristles**

(any cutting length)

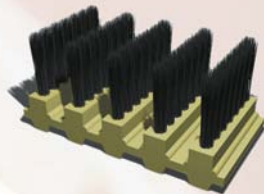

Mypren 0.20 mm dia.

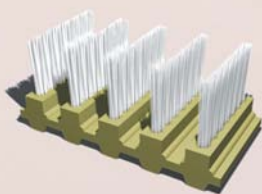
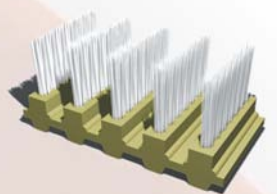
Nylon 6 Ø 0.15 to 0.5 mm  
straight or corrugatedNylon 6.6.  
Ø 0.15 - 0.5 mm  
straight or corrugated**Wire**

(any cutting length)

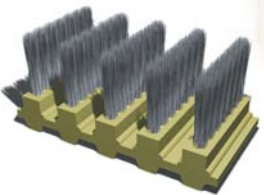
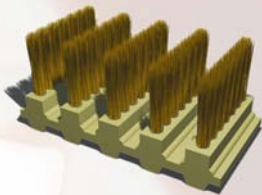
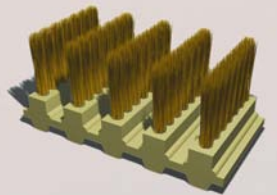
Steel wire  
Ø 0.15 - 0,4 mm  
straight or corrugatedBrass wire  
Ø 0,1 - 0,4 mm  
straight or corrugatedPhosphate bronze  
Ø 0,1 - 0,4 mm  
straight or corrugated

# Mechanical rework

CONTI® SYNCHROFLEX Timing Belts can be mechanically reworked to meet special functional features. Timing belts with a thick backing are especially suited for mechanical rework. They offer far reaching design possibilities for the designer.

Available types: Version FA and coatings/coverings  
Please note that the flexibility of timing belts with a thicker back is reduced and therefore, requiring larger pulley diameters. Belt flexibility can be improved by cross grooving or incisions.

## Back cross milling

Cross grooves on the belt back enhance the flexibility of the belt. Milled grooves are, in as much as they are possible from the technical feasibility point of view, used to improve safe loading and secure positioning of the products on the belts.



## Back longitudinal milling

Independent on the belt pitch, the belt back shaping offers a wide range of design variants for customised solutions. In this manner, belt guiding can be achieved by a trapezoidal back profile, or a round section supported and moved by means of a prism shaped cross section. Dimensions are to be indicated as depth measure  $x$  in relation to the belt back.

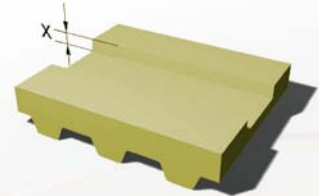

## Back grinding

All CONTI® SYNCHROFLEX Timing Belts can be ground and finished for reasons of precision or in order to obtain a roughened surface. Note that the belts must not be ground to anything less than the overall thickness  $x$  because otherwise the tension members might take damage.

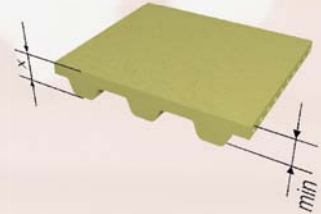

## Edge grinding

Particularly accurate belt width tolerances can be achieved by grinding the belt edges.

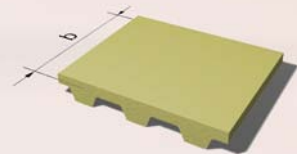

## Removing individual teeth

The removal of individual teeth or groups of teeth is possible and practical due to the high dimensional precision meshing, when the remaining teeth are to serve as precise position load areas.

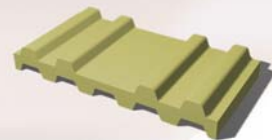

## Longitudinal milling of teeth

Machining the tooth profile is significant for CONTI® SYNCHROFLEX Timing Belts which are protected from running off laterally for instance by bed plates. The processing depth  $x$  is indicated as measured from the tooth top surface.

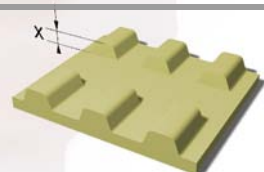

## Perforated timing belts

Aramide tension members should be preferably used with CONTI® SYNCHROFLEX Timing Belts in this type of application.

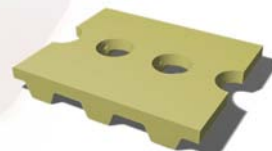

# List of Catalogues

## All our information at a glance

### Polyurethane Timing Belts

BRECO®, BRECOFLEX® timing belts

BRECO® ATN-system

CONTI® SYNCHROFLEX Polyurethane Timing Belts. Overall catalog

CONTI® SYNCHROCHAIN Timing belts for the highest torques

CONTI® SYNCHROCHAIN Heavy-Duty Timing Belts

CONTI® SYNCHRODRIVE Polyurethane Synchronous Drive Belts

CONTI® SYNCHRODRIVE N10 Nubbed Belt

### Polyurethane Flat Belts

BRECO®, BRECOFLEX® Flat Belts

CONTI® POLYFLAT PU Flat Belts

### Pulleys and Accessories

PULLEYS & COMPONENTS for polyurethane timing belt drives

**All product information  
can be requested from  
your Mulco Partner.**

**New information material  
available for download at  
[www.mulco.net](http://www.mulco.net)**



MULCO® is a registered trademark of  
Wilhelm Herm. Müller GmbH & Co. KG,  
Heinrich-Nordhoff-Ring 14, 30826 Garbsen, Germany.

© 2012 Mulco-Europe EWIV. All rights reserved.  
Reproduction of the entirety of text or parts prohibited.







## Sales partners Germany



**Hilger u. Kern Antriebstechnik**

Hilger u. Kern GmbH  
Antriebstechnik  
Käfertaler Straße 253  
68167 Mannheim  
Phone: +49 621 3705-0  
Fax: +49 621 3705-403  
e-mail: antriebstechnik@hilger-kern.de  
www.hilger-kern.com

**WILHELM HERM. MÜLLER**



Wilhelm Herm. Müller GmbH & Co. KG  
Heinrich-Nordhoff-Ring 14  
30826 Garbsen  
Phone: +49 5131 4522-0  
Fax: +49 5131 4522-110  
e-mail: info@whm.net  
www.whm.net



Roth GmbH & Co. KG  
Andernacher Straße 14  
90411 Nürnberg  
Phone: +49 911 99521-0  
Fax: +49 911 99521-70  
e-mail: info@roth-ing.de  
www.roth-ing.de



Anton Klocke Antriebstechnik GmbH  
Senner Straße 151  
33659 Bielefeld  
Phone: + 49 521 95005-01  
Fax: + 49 521 95005-11  
e-mail: info@klocke-antrieb.de  
www.klocke-antrieb.de



REIFF Technische Produkte GmbH  
Tübinger Straße 2-6  
72762 Reutlingen  
Phone: +49 7121 323-0  
Fax: +49 7121 323-318  
e-mail: zahnriemen@reiff-gruppe.de  
www.reiff-tp.de



Walter Rothermundt GmbH & Co. KG  
Am Tannenbaum 2  
41066 Mönchengladbach  
Phone: +49 2161 694620  
Fax: +49 2161 664469  
e-mail: info@rothermundt.de  
www.rothermundt.de

## Sales partner France



BINDER MAGNETIC  
1, Allée des Barbanniers  
92632 Gennevilliers Cedex  
France  
Phone: +33 1 461380-80  
Fax: +33 1 461380-99  
e-mail: info@binder-magnetic.fr  
www.binder-magnetic.fr

## Sales partner Sweden



Aratron AB  
Smidesvägen 4 – 8  
171 41 Solna  
Sweden  
Phone: +46 8 4041-600  
Fax: +46 8 984281  
e-mail: info@aratron.se  
www.aratron.se

## Sales partner Austria



Haberkorn GmbH  
Modcenterstraße 7  
1030 Wien  
Austria  
Phone: +43 1 74074-0  
Fax: +43 1 74074-99  
e-mail: antriebselemente@haberkorn.com  
www.haberkorn.com

## Sales partner Great Britain



Transmission Developments Co. (GB) Ltd  
Dawkins Road  
Poole, Dorset, BH15 4HF  
Great Britain  
Phone: +44 1202 675555  
Fax: +44 1202 677466  
e-mail: sales@transdev.co.uk  
www.transdev.co.uk

## Sales partner Spain



Dinámica Distribuciones S.A.  
Ctra. N. II, km 592,6  
08740 S. Andreu de la Barca  
Spain  
Phone: +34 93 6533-500  
Fax: +34 93 6533-508  
e-mail: dinamica@dinamica.net  
www.dinamica.net

Do you need further information on the Mulco product range? Please contact us.

Mulco-Europe EWIV, Phone: +49 5131 4522-0, Fax: +49 5131 4522-110, e-mail: info@mulco.net, www.mulco.net



Your Mulco partner:

**WILHELM HERM. MÜLLER**



WILHELM HERM. MÜLLER GMBH & CO. KG · Heinrich-Nordhoff-Ring 14 · 30826 Garbsen · Germany  
 phone: +49 5131 4522-0 · fax: +49 5131 4522-110 · e-mail: info@whm.net · www.whm.net

Mulco-Europe EWIV · Heinrich-Nordhoff-Ring 14 · 30826 Garbsen · Germany  
 phone: +49 5131 4522-0 · fax: +49 5131 4522-110 · e-mail: info@mulco.de · www.mulco.net