

ANKER FLEXCO

**TRANSPORTBAND-VERBINDUNGSSYSTEME
CONVEYOR BELT FASTENING SYSTEMS
SYSTÈMES D'AGRAFAGE POUR BANDES TRANSPORTEUSES**

EURO-Preisliste F-2009

01. 01. 2009

EURO-Pricelist F-2009

1 January 2009

Liste de prix EURO F-2009

01/01/2009

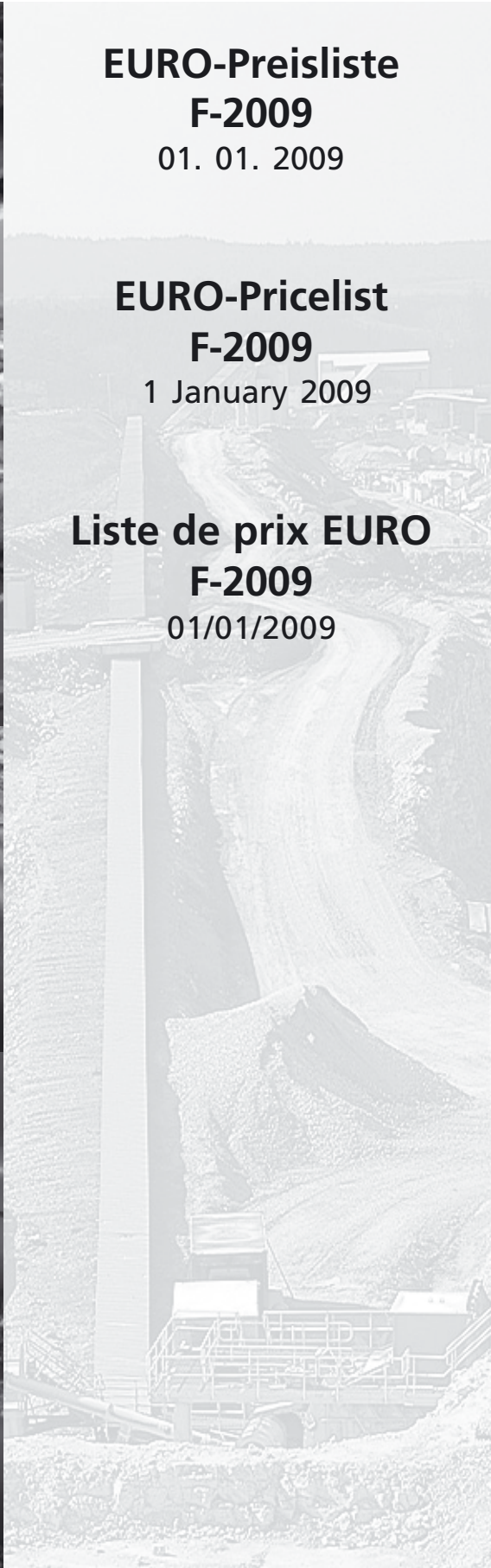
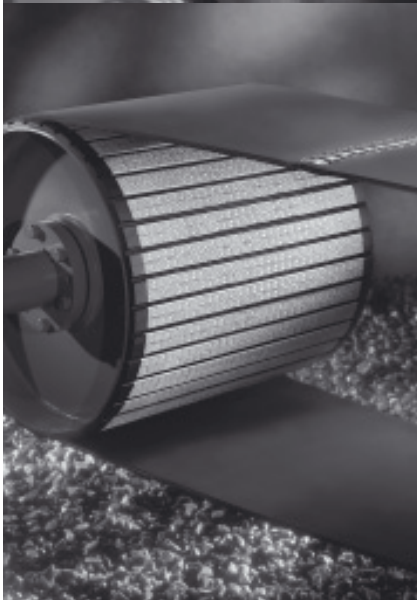
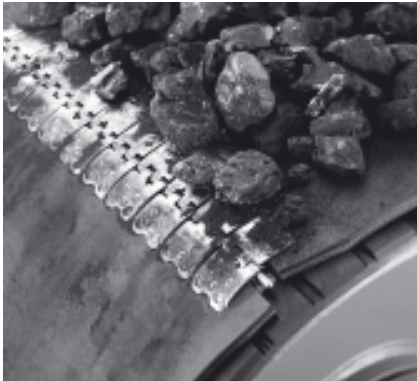

ALLIGATOR Lacing

Transportband - Verbindungssystem für Bandstärken bis 11 mm Conveyor Belt Fastening System for Belts up to 11 mm thick Système d'agrafage pour bandes transporteuses d'épaisseur jusqu'à 11 mm	4
--	---

ALLIGATOR Ready Set

Transportband - Verbindungssystem für Bandstärken von 1,5 bis 6,4 mm Conveyor Belt Fastening System for Belts 1,5 to 6,4 mm thick Système d'agrafage pour bandes transporteuses d'épaisseur 1,5 - 6,4 mm	6
--	---

ALLIGATOR Rivet

Transportband - Verbindungssystem für Rundballenpressen Conveyor Belt Fastening System for Round Balers Système d'agrafage pour bandes transporteuses pour presses à balles	10
---	----

ALLIGATOR Plastic Rivet

Plastikverbinder für Bandstärken von 1,6 - 3,2 mm Plastic Rivet Fasteners for Belts 1,6 - 3,2 mm thick Agrafes plastiques pour bandes transporteuses d'épaisseur 1,6 - 3,2 mm	11
---	----

FLEXCO Rivet Hinged

Transportband - Verbindungssystem für Bandstärken von 6 bis 25 mm Conveyor Belt Fastening System for Belts 6 to 25 mm thick Système d'agrafage pour bandes transporteuses d'épaisseur 6 - 25 mm	12
---	----

FLEXCO Rivet Solid Plate

Transportband - Verbindungssystem für Bandstärken von 6 bis 24 mm Conveyor Belt Fastening System for Belts 6 to 24 mm thick Système d'agrafage pour bandes transporteuses d'épaisseur 6 - 24 mm	18
---	----

FLEXCO Bolt Hinged

Transportband - Verbindungssystem für Bandstärken von 6 bis 16 mm Conveyor Belt Fastening System for Belts 6 to 16 mm thick Système d'agrafage pour bandes transporteuses d'épaisseur 6 - 16 mm	20
---	----

FLEXCO Bolt Solid Plate

Transportband - Verbindungssystem für Bandstärken von 5 bis 30 mm Conveyor Belt Fastening System for Belts 5 to 30 mm thick Système d'agrafage pour bandes transporteuses d'épaisseur 5 - 30 mm	22
---	----

FLEXCO Bolt Hinged / Bolt Solid Plate

Extra Schrauben und Muttern Extra Bolts and Nuts Vis et écrous supplémentaires.	25
--	----

TATCH A CLEAT

Schraubstollen und Führungsprofile Mechanical Belt Cleats and Guides Tasseaux et profils de guidage à visser	26
--	----

FLEXCO

Zubehör für die Bandwartung Belt Maintenance Tools Outillage pour la maintenance des bandes.	28
---	----

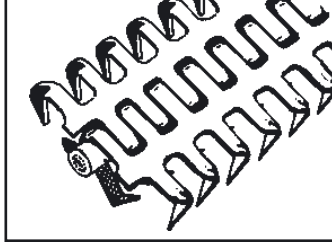

ALLIGATOR Lacing

Transportband-
Verbindungssystem für
Bandstärken bis 11 mm

Conveyor Belt Fastening
System for Belts up to
11 mm thick

Système d'agrafage pour
bandes transporteuses
d'épaisseur jusqu'à 11 mm

Verbindergroße Fastener Size Taille des agrafes	empf. Bandstärkenbereich Belt Thickness Range Épaisseur de bande recommandée mm	empf. kleinster Trommel-Ø rec. min. Pulley-Ø Ø tambour mini.rec. mm
00	- 1,6	25
1	1,6 - 2,4	40
7	2,4 - 3,6	50
15	3,2 - 4,0	65
20	4,0 - 4,8	75

Verbindergroße Fastener Size Taille des agrafes	empf. Bandstärkenbereich Belt Thickness Range Épaisseur de bande recommandée mm	empf. kleinster Trommel-Ø rec. min. Pulley-Ø Ø tambour mini.rec. mm
25	4,8 - 5,6	100
27	5,6 - 7,1	125
35	7,1 - 7,9	175
45	7,9 - 9,5	230
55	9,5 - 11,0	300

Inhalt: Jeder Karton enthält 4
komplette Verbindungen für
die angegebene Bandbreite.

Content: Each Box contains 4
Sets Lacing for the Belt Width
specified.

Contenu: Chaque boîte contient 4
jeux complets de jonction pour la
largeur de bande spécifiée.

Stahl / Steel / Acier

Bestell-Nr. Order-No. No. de réf.	Bandbreite Belt Width Larg. de bande mm	Gewicht Weight Poids kg	Kartonpreis Price per Box Prix par boîte EUR
---	--	----------------------------------	---

00 (4 Verbindersets / Fastener Sets / Jeux de jonction)

00-300	300	0,14	24,20
00-600	600	0,28	49,10
00-900	900	0,42	73,60
00-1200	1200	0,57	98,50

1A

1A-300	300	0,25	23,70
1A-600	600	0,49	48,10
1A-900	900	0,73	72,10
1A-1000	1000	0,82	80,20
1A-1200	1200	0,98	96,40
1A-1500	1500	1,22	120,80

7

7-300	300	0,32	22,80
7-600	600	0,64	46,00
7-900	900	0,96	69,10
7-1000	1000	1,07	76,80
7-1200	1200	1,28	92,40
7-1500	1500	1,61	115,70

15

15-300	300	0,46	26,10
15-600	600	0,91	53,20
15-900	900	1,37	79,80
15-1200	1200	1,83	106,90

20

20-300	300	0,60	30,70
20-600	600	1,20	62,00
20-900	900	1,81	93,90
20-1200	1200	2,42	125,20

Stahl / Steel / Acier

Bestell-Nr. Order-No. No. de réf.	Bandbreite Belt Width Larg. de bande mm	Gewicht Weight Poids kg	Kartonpreis Price per Box Prix par boîte EUR
---	--	----------------------------------	---

25 (4 Verbindersets / Fastener Sets / Jeux de jonction)

25-300	300	0,68	30,40
25-600	600	1,35	61,60
25-900	900	2,03	93,60
25-1200	1200	2,70	124,80

27

27-300	300	0,80	29,30
27-600	600	1,60	59,40
27-900	900	2,38	90,20
27-1200	1200	3,18	120,30

35

35-300	300	1,28	36,80
35-600	600	1,60	76,00
35-900	900	3,84	115,20
35-1200	1200	5,12	154,50

45

45-300	300	1,51	35,10
45-600	600	3,17	74,70
45-900	900	4,75	112,80
45-1200	1200	6,34	150,90

55

55-300	300	2,17	49,60
55-600	600	4,34	99,10
55-900	900	6,34	150,90
55-1200	1200	8,70	203,70

kein Lagerartikel; Lieferzeit 4-5 Wochen
made to order; lead time 4-5 weeks
disponible sur demande; délai 4-5 semaines

Rostfrei W.1.4401 / Stainless AISI 316 / Inoxydable Z6CND17-11

Bestell-Nr. Order-No. No. de réf.	Bandbreite Belt Width Larg. de bande mm	Gewicht Weight Poids kg	Kartonpreis Price per Box Prix par boîte EUR
---	--	----------------------------------	---

00S (4 Verbindersets / Fastener Sets / Jeux de jonction)

00S-300	300	0,14	46,90
00S-600	600	0,28	95,00
00S-900	900	0,42	142,40
00S-1200	1200	0,57	190,60

1S

1S-300	300	0,25	47,40
1S-600	600	0,49	96,00
1S-900	900	0,73	144,00
1S-1000	1000	0,82	160,20
1S-1200	1200	0,98	192,60
1S-1500	1500	1,22	241,30

7S

7S-300	300	0,32	53,70
7S-600	600	0,64	108,90
7S-900	900	0,96	163,40
7S-1000	1000	1,07	181,70
7S-1200	1200	1,28	218,50
7S-1500	1500	1,61	273,70

kein Lagerartikel; Lieferzeit 4-5 Wochen
made to order; lead time 4-5 weeks
disponible sur demande; délai 4-5 semaines



Gelenkriemenverbinder Transmission Belt Lacing Agrafes flexibles pour courroies de transmission

Rostfrei W.1.4401 / Stainless AISI 316 / Inoxydable Z6CND17-11

Bestell-Nr. Order-No. No. de réf.	Verbinder Sets Fastener Sets Jeux de jonction	Gewicht Weight Poids kg	Kartonpreis Price per Box Prix par boîte EUR
---	---	----------------------------------	---

00S	6 X 150	0,09	40,50
1AS	6 X 150	0,15	40,60
7S	6 X 150	0,20	46,00
15S	8 X 300	0,41	68,80
20S	8 X 300	0,55	90,80
25DS	8 X 300	0,64	96,90
27KS	8 X 300	0,78	109,00
35NS	8 X 300	1,23	170,30
45US	8 X 300	1,50	195,50
55WS	8 X 300	2,14	253,40

Stahl / Steel / Acier

Bestell-Nr. Order-No. No. de réf.	Verbinder Sets Fastener Sets Jeux de jonction	Gewicht Weight Poids kg	Kartonpreis Price per Box Prix par boîte EUR
---	---	----------------------------------	---

00	6 X 150	0,09	20,70
1A	6 X 150	0,15	18,30
7	6 X 150	0,20	17,60
15	8 X 300	0,41	24,40
20	8 X 300	0,55	28,60
25D	8 X 300	0,64	28,60
27K	8 X 300	0,78	27,50
35N	8 X 300	1,23	35,30
45U	8 X 300	1,50	34,30
55W	8 X 300	2,14	46,20

Eco Pack

Jede VPE enthält 10 Verbindersets, einzeln verpackt.

Each package contains 10 sets of lacing, individually packed.

Chaque unité d'emballage comprend 10 jeux de jonction, emballés individuellement.

Bestell-Nr. Order-No. No. de réf.	Verbinder Sets Fastener Sets Jeux de jonction	Gewicht Weight Poids kg	Kartonpreis Price per Box Prix par boîte EUR
---	---	----------------------------------	---

15E	10 X 300	0,41	71,10
20E	10 X 300	0,55	83,20
25E	10 X 300	0,64	83,20
27E	10 X 300	0,78	80,20
35E	10 X 300	1,23	102,80

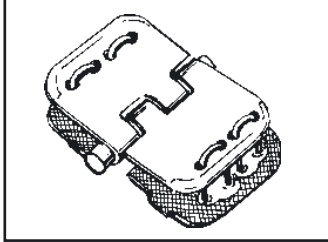

ALLIGATOR Ready Set

Transportband-
Verbindungssystem für
Bandstärken von
1,5 - 6,4 mm

Conveyor Belt Fastening
System for Belts 1,5 - 6,4
mm thick

Système d'agrafage pour
bandes transporteuses
d'épaisseur 1,5 - 6,4 mm

Verbindergroße Fastener Size Taille des agrafes	Für Transportbänder bis zu... N/mm Festigkeit For Belts with a Tensile Strength of up to... N/mm Pour bandes transporteuses à résistance de rupture jusqu'à... N/mm	empf. Bandstärkenbereich Belt Thickness Range Épaisseur de bande recommandée mm	empf. kleinster Trommel-Ø rec. min. Pulley-Ø Ø tambour mini.rec. mm
RS62	200	1,5 - 3,2	50
RS125	315	3,2 - 4,8	75
RS187	400	4,8 - 6,4	100

Inhalt: Jeder J-Karton enthält 4
komplette Verbindungen für
die angegebene Bandbreite.

Content: Each J-box contains 4
Sets Lacing for the Belt Width
specified.

Contenu: Chaque boîte J contient
4 jeux complets de jonction
pour la largeur de bande spécifiée.

Stahl verzinkt / Galvanized Steel / Acier galvanisé

Bestell-Nr. Order-No. No. de réf.	Bandbreite Belt Width Larg. de bande mm	Gewicht Weight Poids kg	Kartonpreis Price per Box Prix par boîte EUR
RS62J12/300NC	300	0,61	45,50
RS62J24/600NC	600	1,22	91,00
RS62J32/800NC	800	1,64	120,40
RS62J40/1000NC	1000	2,05	151,30
RS62J47/1200NC	1200	2,44	181,40
RS62J59/1500NC	1500	3,05	226,80
RS125J12/300NC	300	0,91	47,70
RS125J24/600NC	600	1,78	95,40
RS125J32/800NC	800	2,43	126,30
RS125J40/1000NC	1000	3,04	158,70
RS125J47/1200NC	1200	3,65	190,20
RS125J59/1500NC	1500	4,56	237,70
RS187J12/300NC	300	1,16	50,50
RS187J24/600NC	600	2,69	101,00
RS187J32/800NC	800	3,36	132,30
RS187J40/1000NC	1000	4,20	166,30
RS187J47/1200NC	1200	5,33	199,80
RS187J59/1500NC	1500	6,26	250,10

Rostfrei W.1.4401 / Stainless AISI 316 / Inoxydable Z6CND17-11

Bestell-Nr. Order-No. No. de réf.	Bandbreite Belt Width Larg. de bande mm	Gewicht Weight Poids kg	Kartonpreis Price per Box Prix par boîte EUR
RS62SJ12/300NCS	300	0,61	58,40
RS62SJ24/600NCS	600	1,22	116,80
RS62SJ32/800NCS	800	1,64	155,80
RS62SJ40/1000NCS	1000	2,05	194,30
RS62SJ47/1200NCS	1200	2,44	232,90
RS62SJ59/1500NCS	1500	3,05	291,20
RS125SJ12/300NCS	300	0,91	63,30
RS125SJ24/600NCS	600	1,78	126,50
RS125SJ32/800NCS	800	2,43	167,50
RS125SJ40/1000NCS	1000	3,04	209,00
RS125SJ47/1200NCS	1200	3,65	251,30
RS125SJ59/1500NCS	1500	4,56	315,50
RS187SJ12/300NCS	300	1,16	68,90
RS187SJ24/600NCS	600	2,69	137,80
RS187SJ32/800NCS	800	3,36	181,80
RS187SJ40/1000NCS	1000	4,20	228,50
RS187SJ47/1200NCS	1200	5,33	274,10
RS187SJ59/1500NCS	1500	6,26	342,80

25 Verbindersets (ohne Kupplungsstäbe) · 25 Fastener Sets (without Hinge Pins) · 25 Jeux de jonction (sans axe)

RS62-47/1200-25	1200	13,50	1041,10
RS125-47/1200-25	1200	18,70	1091,50
RS187-47/1200-25	1200	27,50	1104,70

RS62S-47/1200-25	1200	13,50	1319,10
RS125S-47/1200-25	1200	18,70	1392,90
RS187S-47/1200-25	1200	27,50	1403,30

MegAlloy

Bestell-Nr. Order-No. No. de réf.	Inhalt Content Contenu	Gewicht Weight Poids kg	Kartonpreis Price per Box Prix par boîte EUR
125MA*	8 X 300 mm	1,9	141,00
187MA*	8 X 300 mm	2,6	140,50

* ohne Kupplungsdrähte / without hinge pins /
sans tige de jonction

Extra Klammern, rostfrei · Extra Staples, stainless Crampons supplémentaires, inoxydables

Bestell-Nr. Order-No. No. de réf.	Verbindergroße Fastener size Taille d'agrafe	Inhalt Content Contenu	Gewicht Weight Poids kg	Preis Price Prix EUR
S125	125MA	990	0,41	145,00
S187	187MA	990	0,46	145,00

kein Lagerartikel; Lieferzeit 4-5 Wochen
made to order; lead time 4-5 weeks
disponible sur demande; délai 4-5 semaines

Kupplungsdrähte Hinge Material Axes de jonction	Bestell-Nr. Order-No. No. de réf.	Ø mm	Verbindergroße Fastener Size Taille d'agrafe	Inhalt Content Contenu	Gewicht Weight Poids kg	Preis Price Prix EUR
NC Nylostahl Kabel Nylo Stainless Cable Câble nyloacier	NC62-X	2,0	RS62	3 m	0,05	21,50
	NC62-C			30 m	0,45	71,50
	NC1-X	3,6	RS125	3 m	0,09	22,50
	NC1-C			30 m	0,77	75,00
	NC187-X	5,2	RS187	3 m	0,09	36,50
NC187-C	30 m			2,17	121,60	
NCS* Nylorostfrei Kabel Nylo Stainless Cable Câble nyloinox	NCS62-X	2,0	RS62	3 m	0,05	32,90
	NCS62-C			30 m	0,45	109,70
	NCS1-X	3,6	RS125	3 m	0,09	44,80
	NCS1-C			30 m	0,77	149,30
	NCS187-X	5,2	RS187	3 m	0,09	84,40
NCS187-C	30 m			2,17	281,20	
SP Federstahl Spring Steel Acier à ressort * Bandbreite (mm) * Belt Width (mm) * Largeur de bande (mm)	SP62-1000	2,0	RS62	10 X 1000* mm	0,32	80,50
	SP62-1200			10 X 1200* mm	0,37	92,00
	SP62-1500			10 X 1500* mm	0,40	115,00
	SP1-1000	3,6	RS125	10 X 1000* mm	0,68	84,40
	SP1-1200			10 X 1200* mm	0,87	101,20
	SP1-1500			10 X 1500* mm	1,00	126,50
	SP2-1000	4,7	RS187	10 X 1000* mm	1,23	93,20
	SP2-1200			10 X 1200* mm	1,55	111,90
	SP2-1500			10 X 1500* mm	1,80	139,90
	SS* Federstahl rostfrei Stainless Spring Steel Acier inoxydable à ressort * Bandbreite (mm) * Belt Width (mm) * Largeur de bande (mm)	SS62-1000	2,0	RS62	10 X 1000* mm	0,32
SS62-1200		10 X 1200* mm			0,37	124,60
SS62-1500		10 X 1500* mm			0,42	153,20
SS1-1000		3,6	RS125	10 X 1000* mm	0,68	115,40
SS1-1200				10 X 1200* mm	0,87	140,70
SS1-1500				10 X 1500* mm	1,00	175,90
SS2-1000		4,7	RS187	10 X 1000* mm	1,23	159,80
SS2-1200				10 X 1200* mm	1,55	194,80
SS2-1500				10 X 1500* mm	1,95	243,50
Kupplungsstab-Sicherungs- scheiben		62-RET-50		RS62	50	0,04
	125-RET-50		RS125	50	0,05	6,90
Hinge Pin Retaining Washers	187-RET-50		RS187	50	0,06	6,90
Rondelles de butée pour axes de jonction						
Kupplungsstab-Bieger Pin Bender Outil à plier l'axe de jonction	PB1				0,5	19,60



* leicht magnetisch / slightly magnetic / faiblement magnétique

kein Lagerartikel; Lieferzeit 4-5 Wochen
made to order; lead time 4-5 weeks
disponible sur demande; délai 4-5 semaines

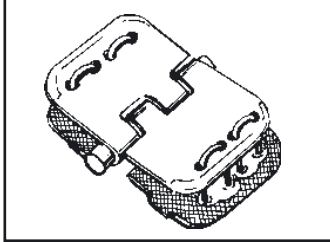

ALLIGATOR Ready Set

Montagewerkzeuge und
Zubehör

Installation Tools and
Accessories

Outils de montage et
accessoires



RSTK-Werkzeugkoffer

mit RSC187-Gerät, Klammersetzplatte,
Hammer, Rillenhobel, Bändecken-
trimmzange.

RSTK-Staple Kit

with RSC187 Installation Tool, Staple
Set Plate, Hammer, Hand Skiver,
Belt Nippers.

RSTK-Coffret d'outillage

avec appareil de montage RSC187,
plaque de pose de crampons, marteau,
rabot pour courroie, pince coupante.

Bestell-Nr. Order-No. No. de réf.	Gerät Tool Outil	Gewicht Weight Poids kg	Kartonpreis Price per Box Prix par boîte EUR
---	------------------------	----------------------------------	---

RSTK4-6	RSC187-6	8,8	517,00
RSTK4-12	RSC187-12	12,1	736,00



Montagegeräte Staple Driving Tools Appareils de montage

Bestell-Nr. Order-No. No. de réf.	Breite Width Largeur mm	Gewicht Weight Poids kg	Kartonpreis Price per Box Prix par boîte EUR
---	----------------------------------	----------------------------------	---

RSC187	50	0,5	91,00
RSC187-4	100	1,5	181,00
RSC187-6	150	3,0	272,00
RSC187-12	300	5,0	543,00
RSC187-18	450	7,5	814,00
RSC187-24	600	9,0	1085,00
RSC187-36	900	14,0	1627,00
RSC187-48	1200	17,0	2169,00
RSC187-60	1500	25,0	2711,00







GOLD CLASS Montagegerät GOLD CLASS Installation Tool GOLD CLASS Appareil de montage

RS-GOLD-DRIVER		5,6	2.999,00
RS-GOLD-INITIAL-12/300		4,8	489,00
RS-GOLD-INITIAL-24/600		9,0	978,00
RS-GOLD-INITIAL-36/900		11,5	1.466,00
RS-GOLD-INITIAL-48/1200		13,6	1.955,00
RS-GOLD-FINAL-12/300		4,9	489,00
RS-GOLD-FINAL-24/600		9,9	978,00
RS-GOLD-FINAL-36/900		12,3	1.466,00
RS-GOLD-FINAL-48/1200		14,5	1.955,00

ST7-5	Block schwarz / Guide Block black / Bloc de guidage noir		61,50
ST7-9	Stößel / Punch / Poinçon		524,40
ST7-29	Setzplatte / Wear Plate / Plaque de pose		22,60

Pressbacken für hydraulische Maschinen Press Plates for Hydraulic Lacers Mâchoires pour agrafeuses hydrauliques

	Für / for / pour	kg	EUR
P2AS	ARU 2000/3000	3,0	265,00
P6AS	AMK 400 / AMU 4000/6000	5,0	312,00

		Bestell-Nr. Order-No. No. de réf.	Gewicht Weight Poids / kg	Preis Price Prix /EUR
	Kupplungsstabschneider Hinge Pin Cutter Pince à couper les axes de jonction	APC-1	0,23	94,00
	Bandeckentrimmzange Belt Nippers Pince coupante	BN-1	0,36	61,00
	Rillenhobel Hand Skiver Rabot pour courroie	RTBS-F	0,06	23,00
	Bandschleifer Belt Grinder Meule pour bande	RB-1	0,34	106,00
	Bandmarkierstift Belt Marker Marqueur de bande	M4	0,01	6,40

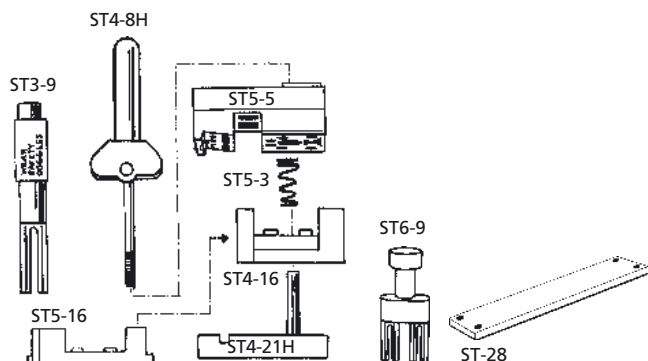

ST3-9	Klammertreiber / Staple Driver / Chasoir de crampons	49,40
ST6-9	Klammertreiber / Staple Driver / Chasoir de crampons	65,40
ST4-8	Nockenhebel kurz für RSC187, RSC187-4, RS-Gold-Initial und RS-Gold-Final Cam Lever Assembly short for RSC187, RSC187-4, RS-Gold-Initial and RS-Gold-Final Levier de tension court pour RSC187, RSC187-4, RS-Gold-Initial et RS-Gold-Final	12,30
ST4-8H	Nockenhebel lang für RSC187-6 und breiter Cam Lever Assembly long for RSC187-6 Levier de tension long pour RSC187-6	12,30
ST4-16	Kamm grün / Comb green / Peigne vert (125/187)	10,40
ST5-16	Kamm gelb / Comb yellow / Peigne jaune (62/125)	10,40
ST5-3	Druckfeder / Spring / Ressort de pression	7,60
ST5-5	Führungsblock / Guide Block / Bloc de guidage	20,30
ST-28	Klammersetzplatte / Staple Set Plate / Plaque de pose de crampons	85,60
ST3-13	Schraube / Bolt / Vis	6,70
ST3-14	Fixierstift / Cam Locating Pin / Goupille	6,70
ST3-15-6	Klemmschiene / Clamp Bar / Rail de serrage	23,10
ST4-21	Amboßsegment kurz für RSC187 und RSC187-4 Anvil short for RSC187 and RSC187-4 Segment d'enclume court pour RSC187 et RSC187-4	59,60
ST4-21H	Amboßsegment / Anvil / Segment d'enclume	59,60
C150	Klammernmagazin für 125MA und 187 MA Staple Dispenser for 125MA and 187 MA Chargeur de crampons pour 125MA et 187 MA	128,10
RSTK-Hammer		41,10
RSTK-Koffer		91,70

kein Lagerartikel; Lieferzeit 4-5 Wochen
made to order; lead time 4-5 weeks
disponible sur demande; délai 4-5 semaines

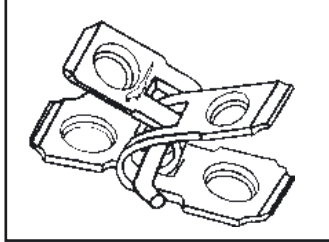

ALLIGATOR Rivet

Transportband-
Verbindungssystem für
Rundballenpressen

Conveyor Belt Fastening
System for Round Balers

Système d'agrafage pour
bandes transporteuses
pour presses à balles

Verbindergroße Fastener Size Taille des agrafes	Für Transportbänder bis zu... N/mm Festigkeit For Belts with a Tensile Strength of up to... N/mm Pour bandes transporteuses à résistance de rupture jusqu'à... N/mm	empf. Bandstärkenbereich Belt Thickness Range Épaisseur de bande recommandée mm	empf. kleinster Trommel-Ø rec. min. Pulley-Ø Ø tambour mini.rec. mm
AR	500	3,2 - 5,6	90

Verbinder · Fasteners · Agrafes

Bestell-Nr. Order-No. No. de réf.	Bandbreite Belt Width Larg. de bande mm	Verbindungen Fastener Sets Jeux d'agrafes	Kartonpreis Price per Box Prix par boîte EUR
Stahl rostfrei / Stainless Steel / Acier inoxydable			
ARJ4/100	100	2	32,60
ARJ6/150	150	2	48,30
ARJ7/175	175	2	50,70
ARJ7/175-6STS	175	6	115,70
ARJ10/250	250	2	84,30
ARJ14/350	350	2	110,70



Extra Kupplungsstäbe und Nieten Extra Hinge Pins and Rivets Axes et rivets supplémentaires

Bestell-Nr. Order-No. No. de réf.	Bandbreite Belt Width Larg. de bande mm	Inhalt Content Contenu	Kartonpreis Price per Box Prix par boîte EUR
gehärteter Stahl, gerillt/steel corrugated, heat-treated/acier rainuré, trempé			
ARSH4/100	100	9	15,90
ARSH6/150	150	8	21,20
ARSH7/175	175	8	24,70
ARSH10/250	250	4	17,70
ARSH14/350	350	4	24,70
AR3-15	Nieten/Rivets	15	8,70

kein Lagerartikel; Lieferzeit 4-5 Wochen
made to order; lead time 4-5 weeks
disponible sur demande; délai 4-5 semaines

Geräte · Tools · Outils

Bestell-Nr. Order-No. No. de réf.	Gerätebreite Tool Width Largeur d'outil mm	Preis pro Stück Price per Piece Prix par pièce EUR
ART-7	175	174,70
ART-10	250	248,10
ART-14	350	305,70



ARTK-Gerätekoffer

mit ART-Gerät, Rillenhobel, Hammer, Kupplungsstababbieger und 2 Kartons ARJ-Verbindersets in einem Plastikkoffer

ARTK-Toolkit

includes ART Installation Tool, Hand Belt Skiver, Hammer, Pin Bender and 2 packages of ARJ fasteners in a plastic tool box

Coffret ARTK

Contenu: outil de pose, rabot pour courroie, marteau, outil pour plier les axes et 2 cartons de jeux d'agrafes ARJ dans un coffret plastique

Bestell-Nr. Order-No. No. de réf.	Gerätebreite Tool Width Largeur d'outil mm	Preis pro Stück Price per Piece Prix par pièce EUR
ARTK-7	175	323,20
ARTK-14	350	567,80



ALLIGATOR Plastic Rivet

Plastikverbinder
für Bandstärken
von 1,6 - 3,2 mm

Plastic Rivet Fasteners
for Belts
1,6 - 3,2 mm thick

Agrafes plastiques pour
bandes transporteuses
d'épaisseur 1,6 - 3,2 mm

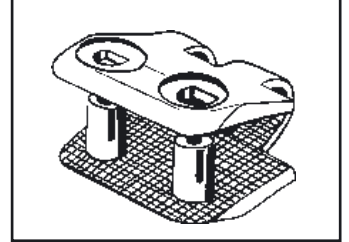

Verbindergröße Fastener Size Taille des agrafes	Für Transportbänder bis zu... N/mm Festigkeit For Belts with a Tensile Strength of up to... N/mm Pour bandes transporteuses à résistance de rupture jusqu'à... N/mm	empf. Bandstärkenbereich Belt Thickness Range Épaisseur de bande recommandée mm	empf. kleinster Trommel-Ø rec. min. Pulley-Ø Ø tambour mini.rec. mm
APF100	75	-2,4	40
APF150	100	1,6 - 3,2	75

Plastikverbinder · Non metallic Fasteners · Agrafes plastiques

Bestell-Nr. Order-No. No. de réf.	Inhalt Content Contenu	Gewicht Weight Poids kg	Kartonpreis Price per Box Prix par boîte EUR	Bestell-Nr. Order-No. No. de réf.	Inhalt Content Contenu	Gewicht Weight Poids kg	Kartonpreis Price per Box Prix par boîte EUR
APF 100W-100*	100	0,29	107,50	APF 150W-100*	100	0,45	110,90
APF 100W-500**	500	0,61	483,70	APF 150W-500**	500	0,97	499,00
APF 100B-100*	100	0,29	107,50	APF 150B-100*	100	0,45	110,90
APF 100B-500**	500	0,61	483,70	APF 150B-500**	500	0,97	499,00
APF 100BLUE-100*	100	0,29	111,20	APF 150BLUE-100*	100	0,45	112,60

* für Bandbreite 1200 mm mit Kupplungsdraht
* for belt width of 1200 mm with hinge material
* pour une largeur de bande de 1200 mm avec axe de jonction

** ausreichend für 6 m Verbindung ohne Kupplungsdraht
** sufficient for 6 m splice without hinge material
** suffit pour 6 m de jonction sans axe de jonction

Kupplungsdrähte · Hinge Material · Axes de jonction

Bestell-Nr. Order-No. No. de réf.	Länge Length Longueur m	Gewicht Weight Poids kg	Kartonpreis Price per Box Prix par boîte EUR	Bestell-Nr. Order-No. No. de réf.	Länge Length Longueur m	Gewicht Weight Poids kg	Kartonpreis Price per Box Prix par boîte EUR
NK2,50	30	0,20	41,60	NK3,50	30	0,40	57,50

Montagegerät und Zubehör · Installation Tool and Accessories · Outillage de montage et accessoires

Bestell-Nr. Order-No. No. de réf.	Gewicht Weight Poids kg	Preis Price Prix EUR	Bestell-Nr. Order-No. No. de réf.	Gewicht Weight Poids kg	Preis Price Prix EUR
MDT220-1	15,90	1866,00	PRL4	0,17	13,60
PCA7-600	4,08	796,00	150T-600	0,57	84,40
Bohrschablonen · Templets · Gabarits			150T-1200	1,08	162,90
100T-600	0,63	84,40	Locheisen · Belt Punch · Poinçon		
100T-1200	1,13	162,90	A100P	0,03	71,90
Locheisen · Belt Punch · Poinçon			A150P	0,03	71,90
Nietkopf · Curling Bit · Tête de pose			S100B	0,03	67,90
S100B	0,03	67,90	S150B	0,03	67,90

kein Lagerartikel; Lieferzeit 4-5 Wochen
made to order; lead time 4-5 weeks
disponible sur demande; délai 4-5 semaines

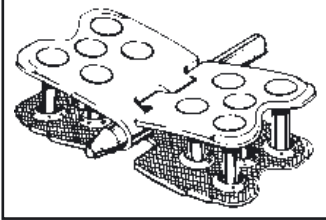

FLEXCO Rivet Hinged

Transportband-
Verbindungssystem
für Bandstärken von
6 bis 25 mm

Conveyor Belt Fastening
System for Belts
6 to 25 mm thick

Système d'agrafage pour
bandes transporteuses
d'épaisseur 6 - 25 mm

Verbindergroße Fastener Size Taille des agrafes	Für Transportbänder bis zu... N/mm Festigkeit For Belts with a Tensile Strength of up to... N/mm Pour bandes transporteuses à résistance de rupture jusqu'à... N/mm	empf. Bandstärkenbereich Belt Thickness Range Épaisseur de bande recommandée mm	empf. kleinster Trommel-Ø rec. min. Pulley-Ø Ø tambour mini.rec. mm
R2	400	6 - 10	125
R5	800	6 - 11	200

Inhalt: Jeder Karton enthält 2 Verbindungsstreifen für die angegebene Bandbreite. Nieten und Kupplungsstäbe extra bestellen.

Content: Each Box contains two Fastener Strips for the Belt Width specified. Order Rivets and Hinge Pins separately.

Contenu: Chaque boîte contient deux bandes d'agrafes pour la largeur de bande spécifiée. Veuillez commander rivets et axes séparément.

Stahl verzinkt / Galvanized Steel / Acier galvanisé

Bestell-Nr. Order-No. No. de réf.	Bandbreite Belt Width Largeur de Bande mm	Gewicht Weight Poids kg	Kartonpreis Price per Box Prix par boîte EUR
R2-20/500	500	0,75	14,60
R2-26/650	650	0,97	18,60
R2-32/800	800	1,20	23,90
R2-40/1000	1000	1,50	29,20
R2-48/1200	1200	1,80	35,80
R2-55/1400	1400	2,00	41,10

Rostfrei W.1.4401 / Stainless AISI 316 / Inoxydable Z6CND17-11

Bestell-Nr. Order-No. No. de réf.	Bandbreite Belt Width Largeur de Bande mm	Gewicht Weight Poids kg	Kartonpreis Price per Box Prix par boîte EUR
R2S-20/500	500	0,75	46,90
R2S-26/650	650	0,97	59,70
R2S-32/800	800	1,20	76,80
R2S-40/1000	1000	1,50	93,80
R2S-48/1200	1200	1,80	115,10

J-Karton / J-Carton / Boîte J

Inhalt: Jeder J-Karton enthält eine komplette Verbindung mit Nieten und NC-Kupplungsstab

Content: Each J-Box contains one complete splice with rivets and NC-hinge pin

Contenu: Chaque boîte J contient une jonction complète avec rivets et axe NC

Bestell-Nr. Order-No. No. de réf.	Bandbreite Belt Width Largeur de Bande mm	Gewicht Weight Poids kg	Kartonpreis Price per Box Prix par boîte EUR
---	--	----------------------------------	---

Bandstärkenbereich / Belt Thickness Range / Épaisseur de bande recommandée: **5 - 7 mm**

R2J-20/500AANC	500	0,75	33,30
R2J-26/650AANC	650	0,97	44,50
R2J-32/800AANC	800	1,20	55,60
R2J-40/1000AANC	1000	1,50	68,20
R2J-48/1200AANC	1200	1,80	84,10

Bandstärkenbereich / Belt Thickness Range / Épaisseur de bande recommandée: **7 - 10 mm**

R2J-20/500ANC	500	0,75	33,70
R2J-26/650ANC	650	0,97	45,00
R2J-32/800ANC	800	1,20	56,30
R2J-40/1000ANC	1000	1,50	69,10
R2J-48/1200ANC	1200	1,80	85,20

Bandstärkenbereich / Belt Thickness Range / Épaisseur de bande recommandée: **7 - 11 mm**

R5J-SE-20/500NC	500	1,27	64,20
R5J-SE-26/650NC	650	1,66	73,10
R5J-SE-32/800NC	800	2,20	82,20
R5J-SE-40/1000NC	1000	2,54	109,00
R5J-SE-48/1200NC	1200	3,13	135,90

MegAlloy

Bestell-Nr. Order-No. No. de réf.	Inhalt Content Contenu	Gewicht Weight Poids kg	Kartonpreis Price per Box Prix par boîte EUR
---	------------------------------	----------------------------------	---

R2MA	10 × 170 mm	1,4	89,20
R5MA-SE	10 × 170 mm	2,2	101,20
R5-1/2MA-SE	10 × 170 mm	2,8	148,70

kein Lagerartikel; Lieferzeit 4-5 Wochen

made to order; lead time 4-5 weeks

disponible sur demande; délai 4-5 semaines

Verbindergroße Fastener Size Taille des agrafes	Für Transportbänder bis zu... N/mm Festigkeit For Belts with a Tensile Strength of up to... N/mm Pour bandes transporteuses à résistance de rupture jusqu'à... N/mm	empf. Bandstärkenbereich Belt Thickness Range Épaisseur de bande recommandée mm	empf. kleinster Trommel-Ø rec. min. Pulley-Ø Ø tambour mini.rec. mm
R5	800	6 - 11	200
R5^{1/2}	1250	9 - 15	250
R6 / RAR6	1400 / 1600	10 - 17	400
R8 / RAR8	2000 / 2500	10 - 17	400
R9S	3500	16 - 25	1050

Inhalt: Jeder Karton enthält 2 Verbinderstreifen für die angegebene Bandbreite. Nieten und Kupplungsstäbe extra bestellen.

Content: Each Box contains two Fastener Strips for the Belt Width specified. Order Rivets and Hinge Pins separately.

Contenu: Chaque boîte contient deux bandes d'agrafes pour la largeur de bande spécifiée. Veuillez commander rivets et axes séparément.

Stahl verzinkt / Galvanized Steel / Acier galvanisé

Bestell-Nr. Order-No. No. de réf.	Bandbreite Belt Width Largeur de Bande mm	Gewicht Weight Poids kg	Kartonpreis Price per Box Prix par boîte EUR
R5-SE-20/500	500	1,27	22,90
R5-SE-26/650	650	1,66	24,70
R5-SE-32/800	800	2,20	35,30
R5-SE-40/1000	1000	2,54	40,50
R5-SE-48/1200	1200	3,13	47,60
R5-SE-55/1400	1400	3,56	56,40
R5-SE-63/1600	1600	4,10	63,40
R5-^{1/2}-SE-26/650	650	2,40	36,00
R5-^{1/2}-SE-32/800	800	2,95	43,60
R5-^{1/2}-SE-40/1000	1000	3,68	59,10
R5-^{1/2}-SE-48/1200	1200	4,49	69,30
R5-^{1/2}-SE-55/1400	1400	5,16	82,10
R5-^{1/2}-SE-63/1600	1600	5,89	92,40
R5-^{1/2}-SE-72/1800	1800	6,63	105,20
R6-SE-32/800	800	4,00	61,00
R6-SE-40/1000	1000	5,00	77,90
R6-SE-48/1200	1200	6,00	91,40
R6-SE-55/1400	1400	7,00	108,30
R6-SE-63/1600	1600	8,00	121,90
R6-SE-72/1800	1800	9,00	138,80
R8-SE-40/1000	1000	5,00	104,10
R8-SE-48/1200	1200	6,00	122,20
R8-SE-55/1400	1400	7,00	145,70
R8-SE-63/1600	1600	8,00	166,50
R8-SE-72/1800	1800	9,00	187,30

RustAlloy - W.1.4016 / AISI 430 / Z8C17 magnetisch / magnetic / magnétique

Bestell-Nr. Order-No. No. de réf.	Bandbreite Belt Width Largeur de Bande mm	Gewicht Weight Poids kg	Kartonpreis Price per Box Prix par boîte EUR
RAR5-SE-26/650	650	1,66	44,40
RAR5-SE-32/800	800	2,20	57,10
RAR5-SE-40/1000	1000	2,54	66,60
RAR5-SE-48/1200	1200	3,13	85,60
RAR5-SE-55/1400	1400	3,56	93,20
RAR5-SE-63/1600	1600	4,10	106,50
RAR5-^{1/2}-SE-26/650	650	2,40	78,70
RAR5-^{1/2}-SE-32/800	800	2,95	79,20
RAR5-^{1/2}-SE-40/1000	1000	3,68	97,90
RAR5-^{1/2}-SE-48/1200	1200	4,49	125,80
RAR5-^{1/2}-SE-55/1400	1400	5,16	149,10
RAR5-^{1/2}-SE-63/1600	1600	5,89	167,80
RAR5-^{1/2}-SE-72/1800	1800	6,63	210,10
RAR6-SE-32/800	800	4,00	104,60
RAR6-SE-40/1000	1000	5,00	135,20
RAR6-SE-48/1200	1200	6,00	166,00
RAR6-SE-55/1400	1400	7,00	190,60
RAR6-SE-63/1600	1600	8,00	216,40
RAR6-SE-72/1800	1800	9,00	252,00
RAR8-SE-40/1000	1000	5,00	148,80
RAR8-SE-48/1200	1200	6,00	182,60
RAR8-SE-55/1400	1400	7,00	208,30
RAR8-SE-63/1600	1600	8,00	238,00
RAR8-SE-72/1800	1800	9,00	267,80

Rostfrei W.1.4401 / Stainless AISI 316 / Inoxydable Z6CND17-11

Bestell-Nr. Order-No. No. de réf.	Bandbreite Belt Width Largeur de Bande mm	Gewicht Weight Poids kg	Kartonpreis Price per Box Prix par boîte EUR
R5S-SE-20/500	500	1,27	106,00
R5S-SE-26/650	650	1,66	128,40
R5S-SE-32/800	800	2,20	154,10
R5S-SE-40/1000	1000	2,54	192,60
R5S-SE-48/1200	1200	3,13	260,00
R5S-SE-55/1400	1400	3,56	293,40
R5S-SE-63/1600	1600	4,10	330,10

Bestell-Nr. Order-No. No. de réf.	Bandbreite Belt Width Largeur de Bande mm	Gewicht Weight Poids kg	Kartonpreis Price per Box Prix par boîte EUR
R9S-SE-40/1000	1000	6,50	323,90
R9S-SE-48/1200	1200	7,70	388,60
R9S-SE-55/1400	1400	9,00	453,40
R9S-SE-63/1600	1600	10,00	518,20
R9S-SE-72/1800	1800	11,50	569,60

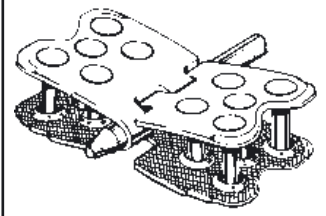

FLEXCO Rivet Hinged

Kupplungsstäbe

Hinge Pins

Axes de jonction

Stahl / Steel / Acier

Bestell-Nr. Order-No. No. de réf.	Ø mm	Verbinder Fasteners Agrafes	Bandbreite Belt Width Largeur de bande mm	Preis Price Prix EUR
NC-500-1	6,3	R2, R5, 375, 550	500	6,90
NC-650-1			650	9,00
NC-800-1			800	11,10
NC-1000-1			1000	13,80
NC-1200-1			1200	16,60
NC-1400-1			1400	19,40
NC-1600-1			1600	22,10
NC-C	Rolle / Coil / Rouleau 30 m			192,50
Kupplungsstab-Sicherungsscheiben / Hinge Pin Retaining Washers / Rondelles de butée pour axes de jonction				
310-RET-50		NC / NCS		7,30
SC-500-1	6,0	R2, R5, 375, 550	500	5,70
SC-650-1			650	7,40
SC-800-1			800	9,10
SC-1000-1			1000	11,40
SC-1200-1			1200	13,60
SC-C	Rolle / Coil / Rouleau 30 m			175,20
AC-500-1	6,3	R2, R5, 375, 550	500	10,10
AC-650-1			650	13,10
AC-800-1			800	16,20
AC-1000-1			1000	20,20
AC-1200-1			1200	24,20
AC-1400-1			1400	28,30
AC-1600-1			1600	32,30
AC-3000-1			3000	66,50
NAC-500-1	6,3	R2, R5, 375, 550	500	10,10
NAC-650-1			650	13,10
NAC-800-1			800	16,20
NAC-1000-1			1000	20,20
NAC-1200-1			1200	24,20
NAC-1400-1			1400	30,40
NAC-1600-1			1600	34,80
AC6-650-1	9,6	R5-1/2, R6, R8	650	24,80
AC6-800-1			800	30,50
AC6-1000-1			1000	38,10
AC6-1200-1			1200	45,70
AC6-1400-1			1400	53,30
AC6-1600-1			1600	60,90
AC6-1800-1			1800	68,50
NAC6-800-1	10,3	R5-1/2, R6, R8	800	33,00
NAC6-1000-1			1000	41,20
NAC6-1200-1			1200	49,50
NAC6-1400-1			1400	57,70
NAC6-1600-1			1600	65,90
NAC6-1800-1			1800	74,20
SC6-650-1	8,8	R5-1/2, R6, R8	650	13,80
SC6-800-1			800	18,40
SC6-1000-1			1000	23,00
SC6-1200-1			1200	27,60
SC6-1400-1			1400	32,20
SC6-1600-1			1600	36,80

Rostfrei / Stainless / Inoxydable

Bestell-Nr. Order-No. No. de réf.	Ø mm	Verbinder Fasteners Agrafes	Bandbreite Belt Width Largeur de bande mm	Preis Price Prix EUR
NCS-500-1	6,3	R2, R5, 375, 550	500	13,70
NCS-650-1			650	17,80
NCS-800-1			800	21,90
NCS-1000-1			1000	27,40
NCS-1200-1			1200	32,80
NCS-1400-1			1400	38,30
NCS-1600-1			1600	43,80
NCS-C	Rolle / Coil / Rouleau 30 m			532,90
SSC-500-1	6,0	R2, R5, 375, 550	500	13,60
SSC-650-1			650	17,70
SSC-800-1			800	21,70
SSC-1000-1			1000	25,50
SSC-1200-1			1200	32,60
ACS-500-1	6,3	R2, R5, 375, 550	500	19,10
ACS-650-1			650	24,90
ACS-800-1			800	30,60
ACS-1000-1			1000	38,30
ACS-1200-1			1200	45,90
ACS-1400-1			1400	53,50
ACS-1600-1			1600	61,20
ACS-3000-1			3000	110,70
ACS6-650-1	9,6	R5-1/2, R6, R8	650	27,30
ACS6-800-1			800	33,60
ACS6-1000-1			1000	42,00
ACS6-1200-1			1200	50,40
ACS6-1400-1			1400	58,80
ACS6-1600-1			1600	67,20
ACS6-1800-1			1800	75,60
NCS962-1000-1	15,9	R9	1000	152,30
NCS962-1200-1			1200	182,80
NCS962-1400-1			1400	209,40
NCS962-1600-1			1600	239,90
NCS962-1800-1			1800	258,10
NCS975-1000-1	19,0	R9	1000	177,10
NCS975-1200-1			1200	225,90
NCS975-1400-1			1400	258,90
NCS975-1600-1			1600	296,50
NCS975-1800-1			1800	327,60
Antimagnetisch / Non-magnetic				
Anti-magnétique				
NB-500-1	6,3	R2, R5, 375, 550	500	24,50
NB-650-1			650	31,80
NB-800-1			800	39,10
NB-1000-1			1000	48,90
NB-1200-1			1200	58,60
NB-C	Rolle / Coil / Rouleau 30 m			994,00

Nieten Auswahltablelle Rivet Selection Chart Tableau de sélection des rivets

Verbinder Fasteners Agrafes	Bandstärke Belt Thickness Epaisseur de bande	Größe Size Largeur
R2	5 - 6	SRAA
	6 - 8	SRA
	7 - 10	SRB
R5	6 - 8	SRA
	7 - 10	SRB
	9 - 11	SRC
R5-1/2	8 - 9	SRB
	9 - 10,5	SRC
	10 - 12	SRC/D
	11 - 13,5	SRD
	13 - 15	SRE
R6 / R8	9 - 11	SRC/D
	10,5 - 13	SRD
	12 - 14	SRE
	13,5 - 16	SRF
	15 - 17	SRG
R9S	16,5 - 19	SRH
	18 - 21	SRI
	20 - 22	SRJ
	21 - 24	SRK

Bei Bändern mit weichen Decken verwenden Sie bitte die nächstkleinere Nietengröße.

We recommend to use the next smaller rivet size for belts with soft covers.

Nous recommandons d'utiliser une taille de rivets inférieure pour des bandes souples.

FLEXCO Rapid Loader-Nieten · Rivets · Rivets

Inhalt 60 Streifen / 1200 Nieten pro Eimer
Content 60 strips / 1200 rivets per bucket
Contenu 60 bandes / 1200 rivets par seau

Bestell-Nr. Order-No. No. de réf.	Größe Size Taille	Farbe Colour Couleur	Gewicht Weight Poids kg	Preis Price Prix EUR
---	-------------------------	----------------------------	----------------------------------	-------------------------------

Stahl / Steel / Acier

CSRLA	A	Rot/Red/Rouge	5,89	320,00
CSRLB	B	Weiß/White/Blanc	6,31	333,30
CSRLC	C	Blau/Blue/Bleu	6,72	346,60
CSRLC/D	C/D	Orange	7,05	359,90
CSRLD	D	Grün/Green/Vert	7,28	359,90
CSRLE	E	Lila/Purple/Lilas	7,53	373,10
CSRLF	F	Gelb/Yellow/Jaune	7,86	386,40
CSRLG	G	Schwarz/Black/Noir	8,11	399,60

Rostfrei / Stainless / Inoxydable

CSRLA-S	A	Rot/Red/Rouge	5,84	640,00
CSRLB-S	B	Weiß/White/Blanc	6,25	666,60
CSRLC-S	C	Blau/Blue/Bleu	6,76	693,10
CSRLC/D-S	C/D	Orange	6,94	719,70
CSRLD-S	D	Grün/Green/Vert	7,21	719,70
CSRLE-S	E	Lila/Purple/Lilas	7,47	746,20
CSRLF-S	F	Gelb/Yellow/Jaune	7,67	915,50
CSRLG-S	G	Schwarz/Black/Noir	7,94	941,60

Nieten pro Verbindung Rivets per Splice Rivets par jonction

Bandbreite Belt Width Largeur de bande	Platten Plates Plaques	R2	R5, 5-1/2, R6	R8/R9S
400	9	36	90	
500	11	44	110	
650	14	56	140	
800	18	72	180	
1000	22	88	220	352
1200	27	108	270	432
1400	31	124	310	496
1600	36	144	360	576
1800	41	164	410	656

FLEXCO-Nieten · Rivets · Rivets

Bestell-Nr. Order-No. No. de réf.	Größe Size Largeur	Inhalt Content Contenu	Gewicht Weight Poids kg	Preis Price Prix EUR
SRAA	SRAA	250	1,00	60,30
SRA	SRA	250	1,04	62,90
SRB	SRB	250	1,13	65,50
SRC	SRC	250	1,18	68,20
SRC/D	SRC/D	250	1,27	70,80
SRD	SRD	250	1,32	70,80
SRE	SRE	250	1,41	73,40
SRF	SRF	250	1,41	76,00
SRG	SRG	250	1,45	78,60
SRH	SRH	250	1,54	81,20
SRI	SRI	250	1,65	83,80
SRJ	SRJ	250	1,73	86,40
SRK	SRK	250	1,85	89,00

SRA-2M	SRA	2000	7,52	452,80
SRB-2M	SRB	2000	8,20	471,60
SRC-2M	SRC	2000	9,15	490,40
SRC/D-2M	SRC/D	2000	9,60	509,20
SRD-2M	SRD	2000	9,92	509,20
SRE-2M	SRE	2000	10,46	528,00
SRF-2M	SRF	2000	11,05	546,80
SRG-2M	SRG	2000	11,28	565,60

Rostfrei W.1.4016 / magnetisch Stainless AISI 430 / magnetic Inoxydable Z8C17 / magnétique

SRAA-S	SRAA	250	1,00	121,80
SRA-S	SRA	250	1,04	127,00
SRB-S	SRB	250	1,13	132,30
SRC-S	SRC	250	1,18	137,60
SRC/D-S	SRC/D	250	1,27	142,80
SRD-S	SRD	250	1,32	142,80
SRE-S	SRE	250	1,41	148,10
SRF-S	SRF	250	1,41	181,70
SRG-S	SRG	250	1,45	186,80

kein Lagerartikel; Lieferzeit 4-5 Wochen
made to order; lead time 4-5 weeks
disponible sur demande; délai 4-5 semaines

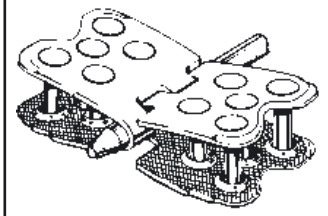

FLEXCO Rivet Hinged

Montagegeräte

Installation Tools

Outils de montage

Bestell-Nr. Order-No. No. de réf.	Breite Width Largeur mm	Gewicht Weight Poids kg	Preis Price Prix EUR
R2T	300	3,00	162,00
MSRTX-30	750	23,00	804,00
MSRTX-36	900	25,00	875,00
MSRTX-42	1050	27,00	978,00
MSRTX-48	1200	29,00	1068,00
MSRTX-60	1500	31,00	1240,00
MSRTX-12-AL	300	10,00	769,00
MSRTX-30-AL	750	21,00	804,00
MSRTX-36-AL	900	22,50	875,00
MSRTX-42-AL	1050	24,00	978,00
MSRTX-48-AL	1200	26,00	1068,00
MSRTX-60-AL	1500	28,00	1240,00
MSRT-30E-AL*	750	35,00	1348,00
MSRT-36E-AL*	900	40,00	1458,00
MSRT-42E-AL*	1050	45,00	1580,00
MSRT-48E-AL*	1200	49,00	1690,00
MSRT-60E-AL*	1500	65,00	2019,00
MSRT-72-AL	1800	47,00	1907,00
MSRT8-48	1200	38,50	1735,00
MSRT8-60	1500	42,00	1995,00
MSRT8-72	1800	46,00	2255,00
MSRT8-84	2100	50,00	2514,00
MSRT8-48E*	1200	54,00	2149,00
MSRT8-60E*	1500	69,00	2601,00
MSRT8-48-AL	1200	35,00	1735,00
MSRT8-60-AL	1500	38,00	1995,00
MSRT8-72-AL	1800	42,00	2255,00
MSRT8-84-AL	2100	45,00	2514,00
MSRT8-48E-AL*	1200	60,00	2149,00
MSRT8-60E-AL*	1500	65,00	2601,00
MSRT9-48	1200	40,00	2597,00
MSRT9-60	1500	42,00	2858,00
MSRT9-72	1800	45,00	3432,00
MSRT9-84	2100	50,00	3673,00

*mit Metallkoffer / with Tool Box / avec coffret métallique

Extra Metallkoffer / Extra Tool Box Coffret métallique supplémentaire

Bestell-Nr. Order-No. No. de réf.	Gewicht Weight Poids kg	Preis Price Prix EUR
TB900	17,50	438,00
TB1200	18,50	465,00
TB1500	22,50	693,00

kein Lagerartikel; Lieferzeit 4-5 Wochen
made to order; lead time 4-5 weeks
disponible sur demande; délai 4-5 semaines

Montagegeräte / Installation Tools / Outillage de montage

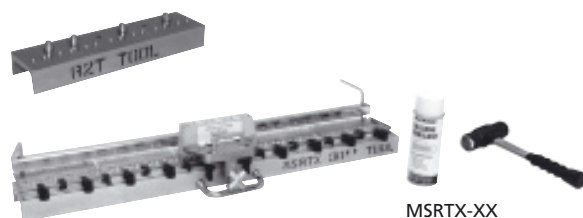

MSRTX-XX

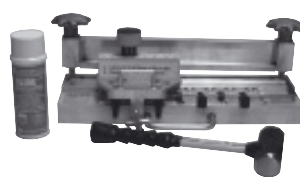

MSRTX-XX-AL



MSRT-XXE-AL

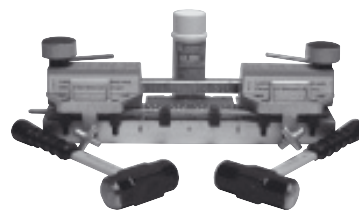

MSRT8-XX/MSRT9-XX

Nientreiber für Bosch-Schlaghammer
Drive Rod for Bosch Demolition Hammer
Chasoir à rivets pour marteau électrique Bosch
EPRD-DR Preis / Price / Prix **63,30**



Schlaghammer BOSCH
Demolition Hammer BOSCH
Marteau électrique BOSCH
GSH5E **Nettopreis / Net Price / Prix net** **748,00**

Bestell-Nr. Order-No. No. de réf.		Gewicht Weight Poids kg	Preis Price Prix EUR
SR700	Führungsblock / Guide Block R5, R 5½, R6	1,36	126,10
SR800	Führungsblock / Guide Block R8, R9S	1,36	162,90
SR759	Nietentreiber / Drive Rod R5, R 5½, R6	0,44	122,60
SR759-2	Nietentreiber / Drive Rod R2	0,40	137,80
SR859-8	Nietentreiber / Drive Rod R8, R9S	0,50	230,20
4FH	Hammer / Hammer	2,00	101,60
SL5-1	Silikonspray / Silicone Spray	0,62	12,00
SR50	Einzelnietentreiber komplett Individual Drive Rod complete	0,35	102,50
SR5-7	Treiberstift / Drive Pin	0,03	54,00
SR-CB	Kanvastasche / Canvas Bag	0,60	67,90
R5-RAR6LP	Lehre zur Nietenauswahl / Rivet Gauge		14,60
R6-R8	Lehre zur Nietenauswahl / Rivet Gauge		14,60

SR759 (R5 / R5½ / R6) SR700 (R5 / R5½ / R6)
SR759-2 (R2)

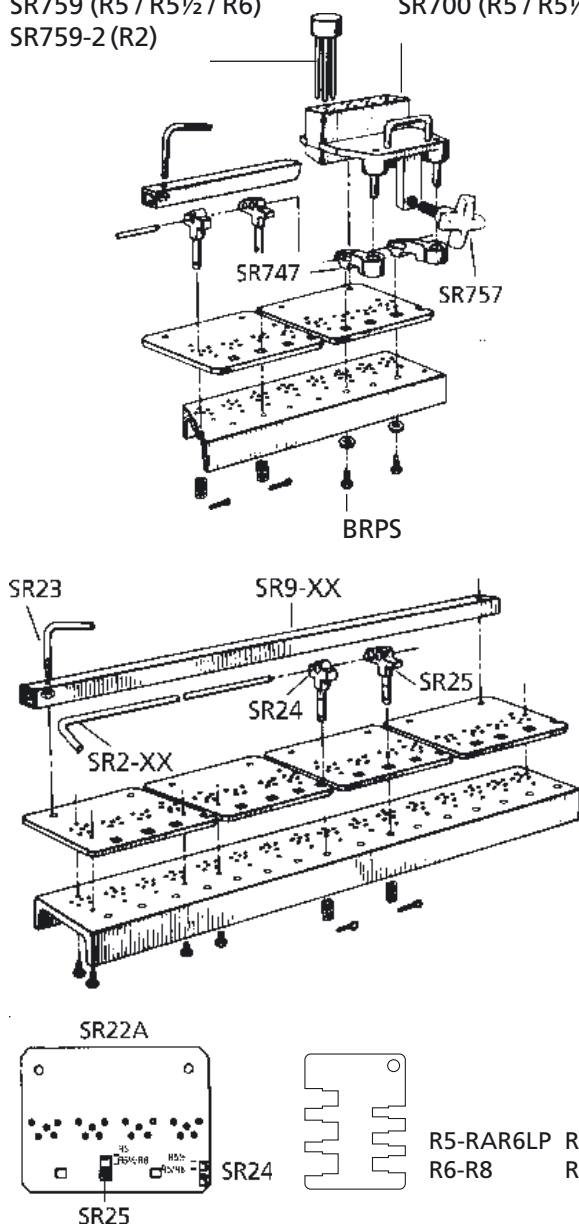

Bestell-Nr. Order-No. No. de réf.		Gewicht Weight Poids kg	Preis Price Prix EUR
---	--	----------------------------------	-------------------------------

Ersatzteile für MSRT / Spare Parts for MSRT

SR23	Fixierschraube / Tightening Bolt	0,10	20,50
SR24	Halterung / Gauge Pin Guide	0,04	29,70
SR25	Halterung / Gauge Pin Guide	0,04	29,70
SR22SA	Amboßplatte / Anvil Plate MSRT	0,80	52,10
SR27SA	Amboßplatte / Anvil Plate MSRT8	0,80	59,90
SR747	Nietenführungseinheit Rivet Guide Locator Assembly	0,10	16,90
SR757	Fixierschraube / Clamping Screw	0,25	34,00
BRPS	Schrauben / Screws (50)	0,31	27,70
SR5-1	Schraubhülsen 2er-Set / Collets Set of 2	0,04	73,30
R5J-R5	Einzelnietensetzer / Single Rivet Set Tool	0,04	11,80

Steckstift für / Gauge Pin for

SR2-30	MSRT-30 / MSRTX-30		20,00
SR2-36	MSRT-36 / MSRTX-36		23,10
SR2-42	MSRT-42 / MSRTX-42		26,20
SR2-48	MSRT-48 / MSRTX-48		29,40
SR2-60	MSRT-60 / MSRTX-60		35,60
SR2-72	MSRT-72 / MSRTX-72		41,90
SR2-84	MSRT-84 / MSRTX-84		48,20

Klemmschiene für / Clamp Bar for

SR9-30	MSRT-30 / MSRTX-30		73,30
SR9-36	MSRT-36 / MSRTX-36		82,50
SR9-42	MSRT-42 / MSRTX-42		91,80
SR9-48	MSRT-48 / MSRTX-48		101,10
SR9-60	MSRT-60 / MSRTX-60		119,70
SR9-72	MSRT-72 / MSRTX-72		138,30
SR9-84	MSRT-84 / MSRTX-84		156,80

Ersatzteile für MSRT-AL / Spare Parts for MSRT-AL

SR22-AL	Amboßplatte / Anvil Plate MSRT-AL	0,10	43,80
SR23-AL	Fixierschraube / Tightening Bolt	0,10	49,20
SR24-AL	Halterung / Gauge Pin Guide	0,04	29,70
SR25-AL	Halterung / Gauge Pin Guide	0,04	29,70
SR27-AL	Amboßplatte / Anvil Plate MSRT8-AL	0,80	59,90
SR747-AL	Nietenführungseinheit Rivet Guide Locator Assembly	0,10	16,90
SR757	Fixierschraube / Clamping Screw	0,25	34,00
SRPS-AL	Schrauben / Screws (50)	0,31	27,70

Steckstift für / Gauge Pin for

SR2-30-AL	MSRT-30 / MSRTX-30		20,00
SR2-36-AL	MSRT-36 / MSRTX-36		23,10
SR2-42-AL	MSRT-42 / MSRTX-42		26,20
SR2-48-AL	MSRT-48 / MSRTX-48		29,40
SR2-60-AL	MSRT-60 / MSRTX-60		35,60
SR2-72-AL	MSRT-72 / MSRTX-72		41,90
SR2-84-AL	MSRT-84 / MSRTX-84		48,20

Klemmschiene für / Clamp Bar for

SR9-30-AL	MSRT-30 / MSRTX-30		272,40
SR9-36-AL	MSRT-36 / MSRTX-36		279,40
SR9-42-AL	MSRT-42 / MSRTX-42		282,30
SR9-48-AL	MSRT-48 / MSRTX-48		285,10
SR9-60-AL	MSRT-60 / MSRTX-60		300,50
SR9-72-AL	MSRT-72 / MSRTX-72		315,90
SR9-84-AL	MSRT-84 / MSRTX-84		323,00
SR91-AL	Klemmschiennutmutter mit Schrauben Clamp Bar Nut with Screws		49,20

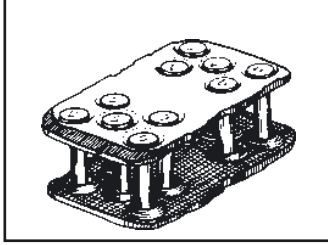

FLECO Rivet Solid Plate

Transportband-
Verbindungssystem für
Bandstärken
von 6 bis 24 mm

Conveyor Belt Fastening
System for Belts
6 to 24 mm thick

Système d'agrafage pour
bandes transporteuses
d'épaisseur 6 - 24 mm

Verbindergroße Fastener Size Taille des agrafes	Inhalt Content Contenu	Für Transportbänder bis zu... N/mm Festigkeit For Belts with a Tensile Strength of up to... N/mm Pour bandes transporteuses à résistance de rupture jusqu'à... N/mm	empf. Bandstärkenbereich Belt Thickness Range Épaisseur de bande recommandée mm	empf. kleinster Trommel-Ø rec. min. Pulley-Ø Ø tambour mini.rec. mm
BR-6		630	6 - 17	350
BR-10	1,5 m	1250	6 - 17	450
BR-14	1,5 m	1600	10 - 24	900

Verbinder · Fasteners · Agrafes

Stahl verzinkt

Galvanized Steel / Acier galvanisé

Bestell-Nr. Order-No. No. de réf.	Bandbreite Belt Width Largeur de Bande mm	Gewicht Weight Poids kg	Kartonpreis Price per Box Prix par boîte EUR
BR6-SE-500	500	1,80	63,20
BR6-SE-650	650	2,30	86,20
BR6-SE-800	800	2,80	111,70
BR6-SE-1000	1000	3,20	144,40
BR6-SE-1200	1200	3,60	188,40

Rostfrei W.1.4401 / Stainless AISI 316 / Inoxydable Z6CND17-11

Bestell-Nr. Order-No. No. de réf.	Bandbreite Belt Width Largeur de Bande mm	Gewicht Weight Poids kg	Kartonpreis Price per Box Prix par boîte EUR
BR6S-SE-500	500	1,80	123,80
BR6S-SE-650	650	2,30	168,00
BR6S-SE-800	800	2,80	217,80
BR6S-SE-1000	1000	3,20	267,10
BR6S-SE-1200	1200	3,60	329,60

Bestell-Nr. Order-No. No. de réf.	Material Material Matériel	Inhalt Content Contenu m	Gewicht Weight Poids kg	Kartonpreis Price per Box Prix par boîte EUR
BR-10-SE	Stahl · Steel	1,5	3,63	140,30
BR-14	Acier	1,5	5,86	196,40
BR-10MA-SE	MegAlloy	1,5	3,63	214,40
BR-14MA		1,5	5,86	332,10
BR-10S-SE	Rostfrei · Stainless Inoxydable	1,5	3,63	325,70

kein Lagerartikel; Lieferzeit 4-5 Wochen
made to order; lead time 4-5 weeks
disponible sur demande; délai 4-5 semaines

FLECO Rapid Loader-Nieten · Rivets · Rivets BR6

Inhalt 32 Streifen / 786 Nieten pro Eimer
Content 32 strips / 786 rivets per bucket
Contenu 32 bandes / 786 rivets par seau

Bestell-Nr. Order-No. No. de réf.	Größe Size Taille	Farbe Colour Couleur	Gewicht Weight Poids kg	Preis Price Prix EUR
Stahl / Steel / Acier				
CBR6A	A	Rot/Red/Rouge	4,75	293,00
CBR6B	B	Weiß/White/Blanc	5,00	298,30
CBR6C	C	Blau/Blue/Bleu	5,25	300,70
CBR6C/D	C/D	Orange	5,50	304,00
CBR6D	D	Grün/Green/Vert	5,75	306,00
CBR6E	E	Lila/Purple/Lilas	6,00	310,20

Rostfrei / Stainless / Inoxydable

CBR6A-S	A	Rot/Red/Rouge	4,75	325,30
CBR6B-S	B	Weiß/White/Blanc	5,00	326,60
CBR6C-S	C	Blau/Blue/Bleu	5,25	330,70
CBR6C/D-S	C/D	Orange	5,50	335,00
CBR6D-S	D	Grün/Green/Vert	5,75	342,10
CBR6E-S	E	Lila/Purple/Lilas	6,00	379,70

FLECO Rapid Loader-Nieten · Rivets · Rivets BR10

Inhalt 60 Streifen / 1200 Nieten pro Eimer
Content 60 strips / 1200 rivets per bucket
Contenu 60 bandes / 1200 rivets par seau

Bestell-Nr. Order-No. No. de réf.	Größe Size Taille	Farbe Colour Couleur	Gewicht Weight Poids kg	Preis Price Prix EUR
Stahl / Steel / Acier				
CSRLA	A	Rot/Red/Rouge	5,89	320,00
CSRLB	B	Weiß/White/Blanc	6,31	333,30
CSRLC	C	Blau/Blue/Bleu	6,72	346,60
CSRLC/D	C/D	Orange	7,05	359,90
CSRLD	D	Grün/Green/Vert	7,28	359,90
CSRLE	E	Lila/Purple/Lilas	7,53	373,10
CSRLF	F	Gelb/Yellow/Jaune	7,86	386,40
CSRLG	G	Schwarz/Black/Noir	8,11	399,60

Rostfrei / Stainless / Inoxydable

CSRLA-S	A	Rot/Red/Rouge	5,84	640,00
CSRLB-S	B	Weiß/White/Blanc	6,25	666,60
CSRLC-S	C	Blau/Blue/Bleu	6,76	693,10
CSRLC/D-S	C/D	Orange	6,94	719,70
CSRLD-S	D	Grün/Green/Vert	7,21	719,70
CSRLE-S	E	Lila/Purple/Lilas	7,47	746,20
CSRLF-S	F	Gelb/Yellow/Jaune	7,67	915,50
CSRLG-S	G	Schwarz/Black/Noir	7,94	941,60

Nieten Auswahltable
Rivet Selection Chart
Tableau de sélection des rivets

Verbinder Fasteners Agrafes	Bandstärke Belt Thickness Épaisseur de bande	Größe Size Largeur
BR-6	6 - 8	SRA
	8 - 10,5	SRB
	9,5 - 12	SRC
	11 - 13,5	SRC/D
	13 - 15	SRD
BR-10	14 - 17	SRE
	6 - 8	SRA
	7 - 10	SRB
	9 - 11	SRC
	10 - 13	SRC/D
	12 - 14	SRD
BR-14	13 - 16	SRE
	15 - 17	SRF
	10 - 13	SRD
	12 - 14	SRE
	13 - 16	SRF
	15 - 17	SRG
	16 - 19	SRH
	18 - 21	SRI
	20 - 22	SRJ
21 - 24	SRK	

Preise der Nieten siehe Seite 15 und 18
 Prices of rivets on page 15 and 18
 Voir pages 15 et 18 pour les prix et les rivets

Nieten pro Verbindung
Rivets per Splice
Rivets par jonction

Bandbreite Belt Width Largeur de bande	BR-6	BR-10	BR-14
400	66	90	126
500	84	110	154
650	114	140	196
800	138	170	238
1000	174	220	308
1200	210	270	378
1400		310	434
1600		360	504
1800		410	574

Montagegeräte · Installation Tools
Outillage de montage

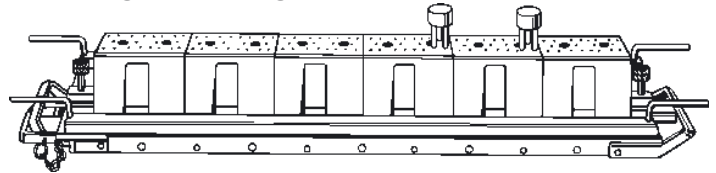

Bestell-Nr. Order-No. No. de réf.	Breite Width Largeur mm	Gewicht Weight Poids kg	Preis Price Prix EUR
---	----------------------------------	----------------------------------	-------------------------------

MBRT6-Montagegeräte Aluminium für **BR6**
 MBRT6-Installation Tools Aluminium for **BR6**
 MBRT6-Outillage de montage en aluminium pour **BR6**

MBRT6-30-AL	750	34,0	1505,00
MBRT6-36-AL	900	38,5	1650,00
MBRT6-42-AL	1050	42,0	1795,00
MBRT6-48-AL	1200	48,0	1941,00
MBRT6-60-AL	1500	54,5	2231,00
MBRT6-72-AL	1800	67,0	2522,00
MBRT6-84-AL	2100	71,0	2813,00

MBRT10-Montagegeräte Aluminium für **BR10**
 MBRT10-Installation Tools Aluminium for **BR10**
 MBRT10-Outillage de montage en aluminium pour **BR10**

MBRT10-30-AL	750	36,0	1605,00
MBRT10-36-AL	900	40,5	1760,00
MBRT10-42-AL	1050	44,0	1915,00
MBRT10-48-AL	1200	47,5	2070,00
MBRT10-60-AL	1500	56,0	2380,00
MBRT10-72-AL	1800	64,0	2690,00
MBRT10-84-AL	2100	73,0	3000,00

MBRTA-Stahl Montagegeräte für **BR10 und BR14**
 MBRTA-Steel Installation Tools for **BR10 and BR14**
 MBRTA-Outillage de montage en acier pour **BR10 et BR14**

MBRTA-42*	1050	57,0	3851,00
MBRTA-48*	1200	75,5	4342,00
MBRTA-60*	1500	81,0	5326,00
MBRTA-72	1800	87,0	5949,00
MBRTA-84	2100	103,0	6933,00

* mit Metallkoffer · with Tool Box · avec coffret métallique

Ersatzteile und Zubehör
Spare Parts and Accessories
Pièces de rechange et accessoires

Bestell-Nr. Order-No. No. de réf.	Gewicht Weight Poids kg	Preis Price Prix EUR
BR300	1,72	206,00
BR359	0,46	93,00
BR500D	1,36	329,90
SR759	0,44	122,60
BR151	0,23	111,10

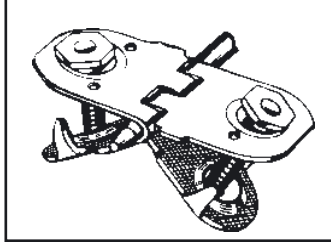

FLESCO Bolt Hinged

Transportband-
Verbindungssystem für
Bandstärken
von 6 bis 16 mm

Conveyor Belt Fastening
System for Belts
6 to 16 mm thick

Système d'agrafage pour
bandes transporteuses
d'épaisseur 6 - 16 mm

Verbindergroße Fastener Size Taille des agrafes	Für Transportbänder bis zu... N/mm Festigkeit For Belts with a Tensile Strength of up to... N/mm Pour bandes transporteuses à résistance de rupture jusqu'à... N/mm	empf. Bandstärkenbereich Belt Thickness Range Épaisseur de bande recommandée mm	empf. kleinster Trommel-Ø rec. min. Pulley-Ø Ø tambour mini.rec. mm
375X	400	6 - 10	125
550	500	6 - 16	200

Inhalt: Jeder J-Karton enthält 1 komplette Verbindung für die angegebene Bandbreite.

Content: Each J-Box contains 1 Set Lacing for the Belt Width specified.

Contenu: Chaque boîte J contient 1 jeu complet de jonction pour la largeur de bande spécifiée.

Stahl verzinkt / Galvanized Steel / Acier galvanisé

Bestell-Nr. Order-No. No. de réf.	Bandbreite Belt Width Larg. de bande mm	Gewicht Weight Poids kg	Kartonpreis Price per Box Prix par boîte EUR
375XJ400NC-SN	400	1,28	48,60
375XJ500NC-SN	500	1,59	59,20
375XJ650NC-SN	650	2,07	79,70
375XJ800NC-SN	800	2,55	100,20
375XJ1000NC-SN	1000	3,18	124,50
375XJ1200NC-SN	1200	3,77	151,90
375XJ1400NC-SN	1400	4,46	182,30
550J500NC-SN	500	1,66	51,70
550J650NC-SN	650	2,16	57,20
550J800NC-SN	800	2,66	76,50
550J1000NC-SN	1000	3,32	96,50
550J1200NC-SN	1200	4,00	116,50
550J1400NC-SN	1400	4,65	136,40

Everdur

antimagnetisch und funkenfrei
non-magnetic and non-sparkling
anti-magnétique et anti-étincelle

375XEJ500NB	500	1,59	223,90
375XEJ650NB	650	2,07	301,80
375XEJ800NB	800	2,55	379,70
375XEJ1000NB	1000	3,18	471,60
375XEJ1200NB	1200	3,77	575,30

Rostfrei W.1.4401 / Stainless AISI 316 / Inoxydable Z6CND17-11

Bestell-Nr. Order-No. No. de réf.	Bandbreite Belt Width Larg. de bande mm	Gewicht Weight Poids kg	Kartonpreis Price per Box Prix par boîte EUR
375XSJ400NCS	400	1,28	176,30
375XSJ500NCS	500	1,59	191,80
375XSJ650NCS	650	2,07	258,80
375XSJ800NCS	800	2,55	325,80
375XSJ1000NCS	1000	3,18	404,60
375XSJ1200NCS	1200	3,77	493,90
375XSJ1400NCS	1400	4,46	593,80
550SJ500SSC	500	1,66	178,10
550SJ650SSC	650	2,16	220,10
550SJ800SSC	800	2,66	262,10
550SJ1000SSC	1000	3,32	330,80
550SJ1200SSC	1200	4,00	399,40
550SJ1400SSC	1400	4,65	468,10
550SJ650NB*	650	2,16	226,80
550SJ800NB*	800	2,66	279,10
550SJ1000NB*	1000	3,32	348,90
550SJ1200NB*	1200	4,00	418,60
550SJ1400NB*	1400	4,50	515,00

* Antimagnetisch / Non-magnetic / Anti-magnétique

MegAlloy

550MAJ650SC-SN	650	2,1	147,90
550MAJ800SC-SN	800	2,7	176,00
550MAJ1000SC-SN	1000	3,3	222,10
550MAJ1200SC-SN	1200	4,0	268,30

Lose-Verbinder (mit Schrauben und Muttern) / Bulk Fasteners (with Bolts and Nuts) Plaques d'agrafes individuelles (avec vis et écrous)

Stahl verzinkt / Galvanized Steel / Acier galvanisé

Bestell-Nr. Order-No. No. de réf.	Platten Plates Plaques	Sets/Eimer Sets/Bucket Jeux/seau	Gewicht Weight Poids kg	Preis Price Prix EUR
375X-3-SN	3	18	3,86	151,50
550-1-SN	1	50	5,44	157,30
550-3-SN	3	18	5,90	169,90







Extra Kupplungsstäbe auf Seite 14
Extra Hinge Pins on Page 14
Tiges supplémentaires page 14

Rostfrei W.1.4401 / Stainless AISI 316 / Inoxydable Z6CND17-11

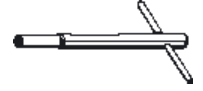
Bestell-Nr. Order-No. No. de réf.	Platten Plates Plaques	Sets/Krt. Sets/Box Jeux/bte.	Gewicht Weight Poids kg	Preis Price Prix EUR
375XS-2	2	25	2,86	512,00
375XS-3	3	18	3,68	553,00
550S-1	1	50	5,49	614,10

Extra Schrauben und Muttern auf Seite 25
Extra Bolts and Nuts on Page 25
Vis et écrous supplémentaires page 25

Montagewerkzeuge · Installation Tools · Outils de montage

Manuelle Montage · Hand Tools · Montage manuel		Bestell-Nr. Order-No. No. de réf.	Verbindergröße Fastener Size Taille d'agrafe	Gewicht Weight Poids kg	Preis Price Prix EUR
	Schraubenbrecher Bolt Breaker Casse-vis	110	375 + 550	0,60	32,70
	Locheisen Punch Poinçon	P1P	375 + 550	0,06	22,50
	Schraubenschlüssel Wrench Clé à tube	S1S	375 + 550	0,09	23,90
Für Schlagschrauber · Power Tools · Outils pour boulonneuse à percussion					
	Locheisen Punch Poinçon	HP1	375 + 550	0,07	21,50
	Schraubenschlüssel Wrench Clé à tube	HW1	375 + 550	0,11	33,20
	Schnellkupplung Quick Change Chuck Mandrin serrage rapide	5552	375 + 550	0,16	80,50
	Füllschlauch orange (30 m) Orange Filler Tubing (30 m) Tuyau orange (30 m)	30894	375 + 550	0,36	31,10

Bohrschablonen · Templets · Gabarits

Bestell-Nr. Order-No. No. de réf.	Bandbreite Belt Width Largeur de bande mm	Gewicht Weight Poids kg	Einzelpreis Price per Box Prix par boîte EUR	Bestell-Nr. Order-No. No. de réf.	Bandbreite Belt Width Largeur de bande mm	Gewicht Weight Poids kg	Einzelpreis Price per Box Prix par boîte EUR
für/for/pour 375				für/for/pour 550			
375X-500	500	1,05	49,00	5-500	500	1,05	43,60
375X-650	650	1,36	53,10	5-650	650	1,36	47,30
375X-800	800	1,68	65,40	5-800	800	1,68	72,70
375X-1000	1000	2,09	81,70	5-1000	1000	2,09	90,80
375X-1200	1200	2,51	98,00	5-1200	1200	2,51	87,20
375X-1400	1400	2,93	114,30	5-1400	1400	2,93	101,70

Bandschneider, Serie 400 Belt Cutter 400 Series Coupeuse de bande Série 400

400430	750	6,42	822,80
400436	900	7,32	893,80
400442	1050	8,59	964,70
400448	1200	8,62	1035,70
400460	1500	10,43	1188,90

FLEXCO-LOK Band FLEXCO-LOK Tape Bande FLEXCO-LOK

Bestell-Nr. Order-No. No. de réf.	für for pour	Länge Length Longueur m	Gewicht Weight Poids kg	Preis Price Prix EUR
FL7C	375X/550	30	0,36	43,00

kein Lagerartikel; Lieferzeit 4-5 Wochen
made to order; lead time 4-5 weeks
disponible sur demande; délai 4-5 semaines

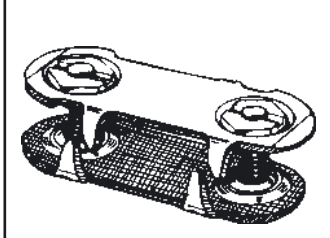

FLEXCO Bolt Solid Plate

Transportband-
Verbindungssystem für
Bandstärken
von 5 bis 30 mm

Conveyor Belt Fastening
System for Belts
5 to 30 mm thick

Système d'agrafage pour
bandes transporteuses
d'épaisseur 5 - 30 mm

Verbindergroße Fastener Size Taille des agrafes	Für Transportbänder bis zu... N/mm Festigkeit For Belts with a Tensile Strength of up to... N/mm Pour bandes transporteuses à résistance de rupture jusqu'à... N/mm	empf. Bandstärkenbereich Belt Thickness Range Épaisseur de bande recommandée mm	empf. kleinster Trommel-Ø rec. min. Pulley-Ø Ø tambour mini.rec. mm
1	315	5 - 11	250
140	400	5 - 11	300
190	630	8 - 14	400
1-1/2	500	11 - 17	400
2	800	14 - 21	700
2-1/4	1000	14 - 30	850
2-1/2	800	19 - 25	1000
3	1000	24 +	1200

Bestell-Nr. Order-No. No. de réf.	Inhalt Content Contenu	Gewicht Weight Poids kg	Kartonpreis Price per Box Prix par boîte EUR	Bestell-Nr. Order-No. No. de réf.	Inhalt Content Contenu	Gewicht Weight Poids kg	Preis pro Eimer Price per Bucket Prix par seau EUR
Stahl / Steel / Acier				Stahl / Steel / Acier			
1E	25	1,32	33,40	1C	100	4,94	133,60
140E	25	2,08	39,90	140C	100	7,12	159,60
190E	25	2,17	45,80	190C	100	8,39	183,20
1-1/2E	25	2,68	41,70	1-1/2C	100	9,93	166,80
2E	25	3,63	52,90	2C	100	13,74	211,60
2-1/4E	25	4,89	122,50	2-1/4C	100	19,18	548,50
2-1/2E	10	2,90	66,20	2-1/2C	100	29,03	740,30
3	10	3,18	69,50	3C	100	31,29	777,90

MegAlloy	Oberplatten/Top Plates/plaquettes supérieures		
140EMA	25	2,08	60,80
190EMA	25	2,17	67,70
1-1/2EMA	25	2,68	62,80
2EMA	25	3,63	79,70

MegAlloy			
140CMA	100	7,12	243,20
190CMA	100	8,39	270,80
1-1/2CMA	100	9,93	251,20
2CMA	100	13,74	318,80

Rostfrei W.1.4401 (antimagnetisch) Stainless AISI 316 (non-magnetic) Inoxydable Z6CND17-11 (anti-magnétique)			
140ES	25	2,08	255,50
190ES	25	2,17	297,40
1-1/2ES	25	2,68	254,80
2ES	25	3,63	318,20

Reparatur-Set Eimer mit 50 Verbindern, HP1, HW1, 110 und ca. 5 m LOK-Band		
Repair Set Bucket containing 50 fasteners, HP1, HW1, 110 and approx. 5 m LOK Tape		
Jeu de réparation Seau avec 50 agrafes, HP1, HW1, 110 et env. 5 m de ruban rigide		
FVS 140	6,24	203,10
FVS 190	6,51	220,40

Everdur (antimagnetisch und funkenfrei) (non-magnetic and non-sparkling) (anti-magnétique et anti-étincelle)			
140EE	25	2,08	163,90
190EE	25	2,17	192,80
1-1/2EE	25	2,68	214,70
2EE	25	3,63	261,10

Platten pro Verbindung Fasteners per Splice Plaquettes par jonction	Bandbreite Belt Width Largeur de bande mm		Grösse Size Taille		Grösse Size Taille		Grösse Size Taille	
			1, 140, 190		1-1/2, 2, 2-1/4		2-1/2, 3	
			90°	45°	90°	45°	90°	45°
400	13	19	10	15	8	12		
500	16	26	13	21	10	16		
650	21	33	17	27	14	21		
800	26	40	21	32	17	26		
1000	32	45	26	36	21	29		
1200	39	54	31	43	26	35		
1400	46	71	37	51	30	40		



VP-Vulcanized Plate			
Bestell-Nr. Order-No. No. de réf.	Bandbreite Belt Width Largeur de bande mm	Gewicht Weight Poids kg	Kartonpreis Price per Box Prix par boîte EUR
140VP	900 (5 X 180 mm)	2,48	136,60
190VP	900 (5 X 180 mm)	2,62	138,50
2VP	900 (5 X 180 mm)	3,58	169,80

FLEXCO Wedlock Verbindung* · FLEXCO Wedlock Splice* · FLEXCO Agrafes Wedlock*

*Weitere Informationen vgl. Broschüre FW/200 · More information in bulletin FW/200 · Plus d'information dans le bulletin FW/200

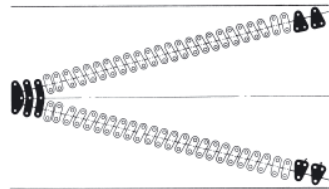

2W	Verbinderset – Splice Kit – Jeu d'agrafes	1,81	188,70
2WS	Verbinderset rostfrei – Stainless Splice Kit – Jeu d'agrafes inoxydables	1,81	334,30
2WL	Verbinderset Zugseite – Leading End Kit – Jeu d'agrafes extrémité tirante	1,36	203,40
2WT	Verbinderset gezogene Seite – Trailing End Kit – Jeu d'agrafes extrémité tirée	1,32	160,50
T2W	Bohrschablonenset – Wedlock Templet Set – Jeu de gabarits	2,86	265,30

Rißreparaturverbinder

Rip Repair Fasteners

Agrafes pour réparation de déchirure

Bestell-Nr. Order-No. No. de réf.	Inhalt Content Contenu	Gewicht Weight Poids kg	Kartonpreis Price per Box Prix par boîte EUR
Stahl / Steel / Acier			
RP1E	25	2,14	96,80
RP2E	25	4,64	131,00
16	50	1,96	69,10

Bestell-Nr. Order-No. No. de réf.	Inhalt Content Contenu	Gewicht Weight Poids kg	Kartonpreis Price per Box Prix par boîte EUR
Rostfrei W.1.4401 (antimagnetisch)			
Stainless AISI 316 (non-magnetic)			
Inoxydable Z6CND17-11 (anti-magnétique)			
RP1ES	25	2,24	348,10
RP2ES	25	4,57	567,50

SS Sechszackverbinder Stahl · Sixpoint Fasteners Steel · Agrafes à griffes acier

Bestell-Nr. Order-No. No. de réf.	Kartonpreis in EUR bei Abnahme von ... Karton Price per Box in EUR when ordering ... Boxes Prix par boîte en EUR en commandant ... boîtes				Stück Pieces Pièces	Bandstärke Belt Thickness Epais. de bande mm	Spitzenlänge Point Length Longueur Pointes mm
	01-09	10-24	25-99	100+			
SS200	8,00	7,20	6,80	6,60	100	2,5 - 4	8
SS201	11,20	10,10	9,60	9,30	100	4 - 6	10
SS202	14,00	12,60	11,90	11,60	100	6 - 8	12
SS203	19,10	17,20	16,30	15,80	100	8 - 10	15
SS204	29,00	26,10	24,70	24,00	100	10 - 13	20
SS205	39,90	35,90	33,90	32,90	100	13 - 15	23
SS206	59,70	53,80	50,80	49,30	100	15 - 18	27
SS207	100,40	90,40	85,40	82,90	100	18 - 21	35

Bohrschablonen · Templets · Gabarits



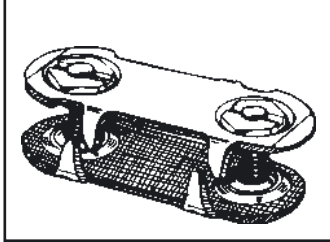





Bestell-Nr. Order-No. No. de réf.	Bestell-Nr. Order-No. No. de réf.	Bestell-Nr. Order-No. No. de réf.	Bandbreite Belt Width Largeur de bande mm	Gewicht Weight Poids kg	Einzelpreis Price per Box Prix par boîte EUR
1-500	140-500	190-500	500	1,0	32,10
1-650	140-650	190-650	650	1,3	34,80
1-800	140-800	190-800	800	1,6	42,80
1-1000	140-1000	190-1000	1000	2,0	53,50
1-1200	140-1200	190-1200	1200	2,4	64,20
1-1400	140-1400	190-1400	1400	2,8	74,90
1-1/2-800	2-800		800	1,6	49,10
1-1/2-1000	2-1000		1000	2,0	61,40
1-1/2-1200	2-1200		1200	2,4	73,70
1-1/2-1400	2-1400		1400	2,8	86,00
2-1/4-800	2-1/2-800	3-800	800	1,6	86,90
2-1/4-1000	2-1/2-1000	3-1000	1000	2,0	108,60
2-1/4-1200	2-1/2-1200	3-1200	1200	2,4	130,30
2-1/4-1400	2-1/2-1400	3-1400	1400	2,8	152,00

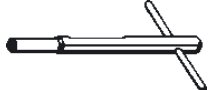

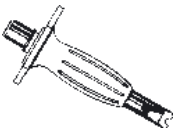
Montagewerkzeuge für
FLEXCO
Bolt Solid Plate

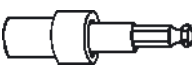
Installation Tools
for FLEXCO
Bolt Solid Plate

Outils de montage
pour FLEXCO
Bolt Solid Plate

		Bestell-Nr. Order-No. No. de réf.	Verbindegröße Fastener Size Taille d'agrafe	Gewicht Weight Poids kg	Preis Price Prix EUR
Manuelle Montage · Hand Tools · Montage manuel					
	Schraubenbrecher	110	1, 140, 190, RP1, 375X, 550	0,60	32,70
	Bolt Breaker	112	1-1/2, 2, 2-1/4, RP2	0,66	32,70
	Casse-vis	113	2-1/2, 3	0,90	36,90
	Locheisen	P1P	1, 140, 190, RP1, 375X, 550	0,06	22,50
	Punch	P2P	1-1/2, 2, 2-1/4, RP2	0,10	22,50
	Poinçon	P3P	2-1/2, 3	0,13	27,20
	Steckschlüssel	S1S	1, 140, 190, RP1, 375X, 550	0,09	23,90
	Wrench	S2S	1-1/2, 2, 2-1/4, RP2	0,09	23,90
	Clé à tube	S3S	2-1/2, 3	0,11	31,90
	Schraubhorn Bolthorn Corne à vis	2BH		0,02	3,50
	Meißel	C1C	1, 140, 190, RP1, 375X, 550	0,54	114,60
	Cracking Chisel Burin	C2C	1-1/2, 2, 2-1/4, RP2	0,54	114,60
Für Schlagschrauber · Power Tools · Outils pour boulonneuse à percussion					
	Locheisen	HP1	1, 140, 190, RP1, 375X, 550	0,07	21,50
	Punch	HP2	1-1/2, 2, 2-1/4, RP2	0,07	21,50
	Poinçon	HP3	2-1/2, 3	0,10	30,30
	Steckschlüssel	HW1	1, 140, 190, RP1, 375X, 550	0,11	33,20
	Wrench	HW2	1-1/2, 2, 2-1/4, RP2	0,14	32,60
	Clé à tube	HW3	2-1/2, 3	0,17	39,20
	Schnellkupplung Quick Change Chuck Mandrin serrage rapide	5552	für HP + HW Werkzeuge for HP + HW Tools pour Outillage HP + HW	0,16	80,50
	Silikon Spray Silicone Spray Silicone	SL5-1	0,62		12,00
FLEXCO-LOK Band · FLEXCO-LOK Tape · Ruban rigide FLEXCO-LOK					
	Bestell-Nr. Order-No. No. de réf.	für for pour	Länge Length Longueur m	Gewicht Weight Poids kg	Preis Price Prix EUR
	FL7C	1, 140	30	0,36	43,00
FL11C	190, 1-1/2, 2, 2-1/4, 2-1/2, 3	30	0,45	59,00	
	Makita Schlagschrauber Nr. TW 0350 Nettopreis 314,00	Makita Impact Tool Nr. TW 0350 Net Price 314,00	Boulonneuse Makita n° TW 0350 Prix net 314,00		

**Extra Schrauben
Extra Bolts
Vis supplémentaires**

Stahl / Steel / Acier

Bestell-Nr. Order-No. No. de réf.	Verbindergröße Fastener Size Taille des agrafes	Gewicht Weight Poids kg	Preis 100 St. Price per 100 Prix par 100 EUR
20391	1	0,80	28,70
20398	RP1, 375X	1,10	39,90
20399	140, 190, 550	1,00	44,00
20406	1-1/2, 2, RP2	1,80	38,70
20410	2-1/4	2,20	93,00
20414	2-1/2, 3	3,40	73,40

Rostfrei / Stainless / Inoxydable

20400	140, 190, 375X, 550, RP1	1,50	132,60
20407	1-1/2, 2, RP2	1,80	164,70
20411	2-1/4	2,20	263,70

Everdur

20397	140, 190	0,84	146,40
20409	1-1/2, 2, RP2	1,68	179,40

**Extra Muttern
Extra Nuts
Écrous supplémentaires**

Stahl / Steel / Acier

Bestell-Nr. Order-No. No. de réf.	Verbindergröße Fastener Size Taille des agrafes	Gewicht Weight Poids kg	Preis 100 St. Price per 100 Prix par 100 EUR
20377	1, 140, 190, RP1 + 375X, 550	0,30	30,20
20378	1-1/2, 2, 2-1/4, RP2	0,50	37,70
20379	2-1/2, 3	1,00	124,50

Rostfrei / Stainless / Inoxydable

20381	1, 140, 190, RP1 + 375X, 550	0,30	233,00
20382	1-1/2, 2, 2-1/4, RP2	0,50	123,30

Everdur

20387	1, 140, 190, RP1 + 375X	0,30	98,70
20388	1-1/2, 2, 2-1/4, RP2	0,50	123,30

kein Lagerartikel; Lieferzeit 4-5 Wochen
made to order; lead time 4-5 weeks
disponible sur demande; délai 4-5 semaines

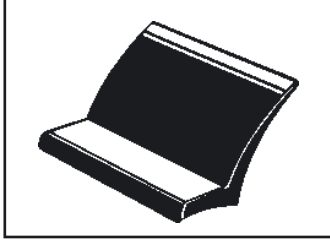

TATCH A CLEAT

Schraubstollen und
Führungsprofile

Mechanical Belt Cleats and
Guides

Tasseaux et profils de
guidage à visser

Hinweis:
Weitere Informationen
finden Sie in unserer
Broschüre TAC 100.

Notice:
For further information see
our Brochure TAC 100.

Renvoi:
Pour d'autres informations
veuillez consulter notre
brochure TAC 100.

Tatch-A-Cleat	Zusammensetzung Compound Composition	Min. Trommel-Ø Min. Pulley-Ø Ø tambour mini mm	Temperatur- einsatzbereich Temperature Service Range Conditions de température	Abriebbeständigkeit Abrasion Resistance Résistance à l'abrasion	Ölbeständigkeit Oil Resistance Résistance à l'huile	Säurebeständigkeit Acid Resistance Résistance aux acides
L	Weiß/Schwarz Nitril - FDA White/Black Nitril - FDA blanc/noir nitril - FDA	50	-40° bis / up to / jusqu'à + 110° C	+	++	+
EC	Schwarz EPDM Black EPDM noir EPDM	EC1-3: 75 EC4: 100 EC6: 150	-55° bis / up to / jusqu'à + 150° C	++	N/A	++
HD	Schwarz SBR Black SBR noir SBR	75	-40° bis / up to / jusqu'à + 80° C	++	N/A	0
LUG/PEG	Tan Isopren FDA Tan Isoprene FDA tan isoprène FDA	80	-40° bis / up to / jusqu'à + 80° C	++	N/A	+
GUIDE	Schwarz Neopren Black Neoprene noir néoprène	A: 100 B: 150 C: 200	-40° bis / up to / jusqu'à + 110° C	+	+	+

HD Profile Cleats Profils



	Bestell-Nr. Order-No. No. de Réf.	Höhe Height Hauteur mm	Inhalt Content Contenu	Gewicht Weight Poids kg	Preis Price Prix EUR	
Schwarz, verzinkte Schrauben Black, plated Fasteners Noir, vis galvanisées	HD-1	25	10X610 mm	5,22	384,60	
	HD-2	50	5X610 mm	4,30	254,00	
Schwarz, rostfreie Schrauben Black, stainless Fasteners Noir, vis inoxydables	HD-1S	25	10X610 mm	5,35	545,10	
	HD-2S	50	5X610 mm	4,30	298,70	
Extra Schrauben und Unterlegscheiben Extra Bolts and Washers Vis et rondelles supplémentaires	verzinkt, plated, galvanisées	HD1-F	25	123	1,24	62,70
		HD1-1/4-F	32,5	123	1,50	74,60
	rostfrei, stainless, inoxydables	HD1-FS	25	123	1,24	229,60
		HD2-1/4-FS	32,5	123	1,50	272,80

EC Profile Cleats Profils



Schwarz, verzinkte Schrauben Black, plated Fasteners Noir, vis galvanisées	EC1-1/4	32	5X1220 mm	5,67	211,40
	EC2	51		7,03	283,70
	EC3	76		9,98	317,80
	EC4	102		14,97	469,70
	EC6	152	2X1220 mm	12,84	455,00

Extra Schrauben Extra Bolts Vis supplémentaires	verzinkt, plated, galvanisées	ECF	61	1,27	42,60
		EC4F	61	1,50	42,60
	rostfrei, stainless, inoxydables	EC6F	33	0,91	23,90
		ECFS	61	1,32	258,70

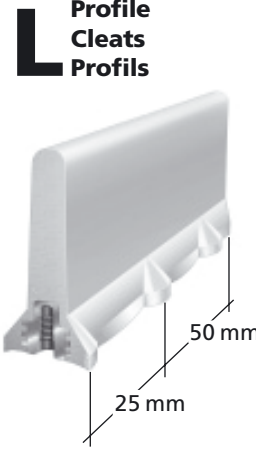
		Bestell-Nr. Order-No. No. de réf.	Höhe Height Hauteur mm	Inhalt Content Contenu	Gewicht Weight Poids kg	Preis Price Prix EUR
 <p>Profile Cleats Profils</p>	Schwarz, verzinkte Schrauben Black, plated Fasteners Noir, vis galvanisées	L5/8-B	16	10X610 mm	3,31	429,00
		L1-B	25		4,22	430,00
		L1-1/2-B	38		5,08	431,00
		L2-B	54		6,35	541,00
		L3-B	76		8,31	560,00
	Schwarz, rostfreie Schrauben Black, stainless Fasteners Noir, vis inoxydables	L5/8-BS	16	10X610 mm	3,31	484,00
		L1-BS	25		4,22	485,00
		L1-1/2-BS	38		5,08	486,00
		L2-BS	54		6,35	600,00
		L3-BS	76		8,31	619,00
	Weiß, verzinkte Schrauben White, plated Fasteners Blanc, vis galvanisées	L5/8-W	16	10X610 mm	3,31	472,00
		L1-W	25		4,22	473,00
		L1-1/2-W	38		5,58	474,00
		L2-W	54		6,58	597,00
		L3-W	76		8,75	617,00
	Weiß, rostfreie Schrauben White, stainless Fasteners Blanc, vis inoxydables	L5/8-WS	16	10X610 mm	3,31	531,00
	L1-WS	25		4,22	532,00	
	L1-1/2-WS	38		5,58	532,00	
	L2-WS	54		6,58	655,00	
	L3-WS	76		8,75	676,00	

Extra Schrauben und Unterlegscheiben für L/LUG/PEG

Extra Bolts and Washers for L/LUG/PEG

Vis et rondelles supplémentaires pour L/LUG/PEG

Bandstärkenbereich
Belt Thickness Range
Épaisseur de bande
L1/2-F/FS -8 mm
L5/8-F/FS 7-11 mm
L3/4-F/FS >11 mm

* Standardschraube in allen Modell L, LG, PG Stollen
Standard Bolt in all Modell L, LG, PG Cleats
Vis standard pour tous les modèles tasseaux L, LG, PG

verzinkt / plated / galvanisées

L1/2-F*	12	123	0,45	23,20
L5/8-F	16	123	0,45	28,90
L3/4-F	19	123	0,59	29,70

rostfrei / stainless / inoxydables

L1/2-FS*	12	123	0,45	71,50
L5/8-FS	16	123	0,45	85,80
L3/4-FS	19	123	0,59	86,50

LUG Profile Cleats Profils



PEG Profile Cleats Profils



verzinkte Schrauben / plated fasteners / vis galvanisées

LG1-1/2-C	38	100	3,00	438,60
LG-2-C	51	100	3,21	468,20
PG2	51	100	1,95	345,80
PG3	76	100	3,13	405,40

rostfreie Schrauben / stainless bolts / vis inoxydables

PG2S	51	100	1,95	431,60
PG3S	76	100	3,13	491,20

GUIDE Profile / Cleats Profils



Schwarz, verzinkte Schrauben
Black, plated Fasteners
Noir, vis galvanisées

Schwarz, rostfreie Schrauben
Black, stainless Fasteners
Noir, vis inoxydables

A10	10X200 mm	13X10	0,45	89,40
B10		16X12	0,59	96,30
C10		26X16	1,49	151,40
A10S	10X200 mm	13X10	0,45	100,30
B10S		16X12	0,59	122,40
C10S		26X16	1,49	165,10

Extra Unterlegscheiben Extra Washers Rondelles supplémentaires

verzinkt, plated, galvanisées
Rostfrei / Stainless / Inoxydable
verzinkt, plated, galvanisées

CW1024	L/LUG/PEG	100	0,20	10,40
CWS1024	L/LUG/PEG	100	0,20	40,00
CW25/100	HD/EC	100	0,40	0,30
CWS25/100	HD/EC	100	0,40	0,70



kein Lagerartikel; Lieferzeit 4-5 Wochen
made to order; lead time 4-5 weeks
disponible sur demande; délai 4-5 semaines

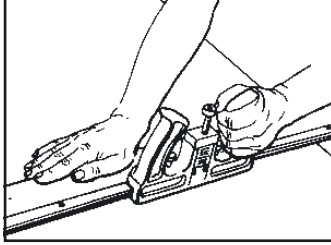

Zubehör für die Band-
wartung

Belt Maintenance Tools

Outillage pour la
maintenance des bandes

		Bestell-Nr. Order-No. No. de réf.	Breite Width Largeur mm	Gewicht Weight Poids kg	Preis Price Prix EUR		
300 Serie Bandschneider 300 Series Belt Cutter Série 300 Coupeuse	für Bänder bis 30 mm for belts up to 30 mm pour bandes jusqu'à 30 mm	300324	600	8,00	571,00		
		300330	750	8,70	600,00		
		300336	900	9,00	656,00		
		300342	1050	11,80	760,00		
		300348	1200	16,00	796,00		
		300360	1500	14,90	884,00		
		300372	1800	17,00	992,00		
		30023	Klinge/Blade/Lame	0,10	31,90		
		300	Griff/Handle/Manche	1,10	328,00		
		8D	Nägel/Nails/Clous	0,50	9,80		
900 Serie Bandschneider 900 Series Belt Cutter Série 900 Coupeuse de bande	für Bänder bis 38 mm for belts up to 38 mm pour bandes jusqu'à 38 mm	900924	600	12,00	1421,00		
		900936	900	14,00	1466,00		
		900948	1200	17,00	1553,00		
		900960	1500	19,00	1674,00		
		900972	1800	14,00	1786,00		
		900984	2100	17,00	2297,00		
		900CBK	Klinge/Blade/Lame	19,00	141,00		
		840SD	Rechtw. Anschlagschiene Squaring device Jeu d'équerres	0,10	153,00		
		Ersatzteile für 820, 840, 845LD Bandschneider Spare Parts for 820, 840, 845LD Belt Cutters Pièces de rechange pour coupeuses de bande 820, 840, 845LD					
		820/840-1CB	Klinge/Blade/Lame	0,10	83,00		
845-1CB	Klinge/Blade/Lame	0,10	83,00				
840SD	Rechtw. Anschlagschiene Squaring device Jeu d'équerres	0,10	153,00				
Elektro Bandschneider Electric Belt Cutter Coupeuse de bande électrique	230 V / 50 Hz	ITEC-170	Schnitttiefe max. 25 mm Cut Depth max. 25 mm Capacité de coupe max .25 mm	14,30	3024,00		
		ITEC-220	Schnitttiefe max. 50 mm Cut Depth max. 50 mm Capacité de coupe max. 50 mm	18,40	3769,50		
		Ersatzmesser - Spare Blades - Lames de rechange					
		ITEC-170-BLADE	für / for / pour ITEC-170	1,00	327,60		
ITEC-220-BLADE	für / for / pour ITEC-220	1,50	514,50				
Rauhmaschine elektrisch Electric Buffing Machine Machine électrique à meuler	230 V / 50 Hz	ITMBM		10,00	2608,20		
		VW110-390-4	Satz mit 4 Rauhscheiben Set of 4 vain wheels Jeu de 4 meuleuses	1,60	266,70		

Zubehör für die Band-
wartung

Belt Maintenance Tools

Outillage pour la
maintenance des bandes



Bandhobel
Belt Skiver
Rabot pour bande

Bestell-Nr. Order-No. No. de réf.	EDV-Nr. Item-No. No. inf.	Breite Width Largeur mm	Gewicht Weight Poids kg	Preis Price Prix EUR
FSK-1A	31995	Hobel/Skiver/Rabot	9,30	1481,00
FSK-1BA	31996	verbesserte Klinge improved Blade Lame améliorée	0,10	198,00
FSK-1B	31996	Klinge/Blade/Lame	0,10	88,00

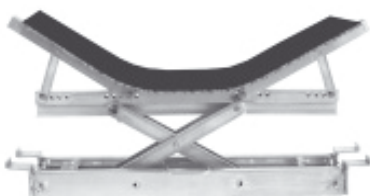

Gurtheber
FLEX-Lifter
Élévateur de bande

Bestell-Nr. Order-No. No. de réf.	für Bandbreite von for Belt Width of pour largeur de bande de mm	Gewicht Weight Poids kg	Preis Price Prix EUR
FLEX-LIFTER M	900 - 1500	39,00	2125,00
FLEX-LIFTER L	1200 - 1800	57,20	2323,00



Akkuschrauber
für Flex-Lifter

DeWalt DC920KB
Nettopreis 419,00

Cordless Drill
for Flex-Lifter

DeWalt DC920KB
Net Price 419,00

Visseuse sans fil
pour Flex-Lifter

DeWalt DC920KB
Prix net 419,00

Bandspannsysteme
Far-Pull Belt Clamps
Pinceur de bande

mit 4 Klemmbalken
und 4 Klemmen
with 4 clamp
bars and 4 scissors
avec 4 barres et
4 pinces



Bestell-Nr. Order-No. No. de réf.	Bandbreite Belt Width Largeur de bande mm	Gewicht Weight Poids kg	Preis pro Satz Price per Set Prix par jeu EUR
LSHD30/750	750	29,50	1217,00
LSHD36/900	900	32,50	1267,00
LSHD42/1050	1050	35,00	1319,00
LSHD48/1200	1200	39,00	1368,00
LSHD60/1500	1500	44,00	1474,00
LSHD72/1800	1800	48,00	1529,00

Klemmbalkenset (2 Stück)
Belt Clamp Bar Set (2 Pieces)
Jeu de barres (2 pièces)

LSHDB30/750	750	9,00	343,00
LSHDB36/900	900	10,50	370,00
LSHDB42/1050	1050	12,00	397,00
LSHDB48/1200	1200	13,50	425,00
LSHDB60/1500	1500	16,50	480,00
LSHDB72/1800	1800	18,00	534,00
LSHDS Klemme / Scissors / Pinces		2,75	141,00

kein Lagerartikel; Lieferzeit 4-5 Wochen
made to order; lead time 4-5 weeks
disponible sur demande; délai 4-5 semaines

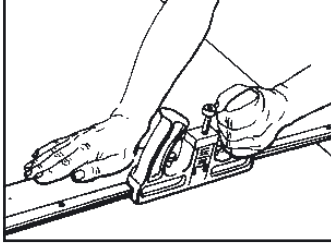

Zubehör für die Band-
wartung

Belt Maintenance Tools

Outillage pour la
maintenance des bandes

		Bestell-Nr. Order-No. No. de réf.	Gewicht Weight Poids kg	Preis Price Prix EUR
	Kupplungsstabschneider Hinge Pin Cutter Pince à couper les axes de jonction	APC-1	0,23	94,00
	Bandeckentrimmzange Belt Nippers Pince coupante	BN-1	0,36	61,00
	Rillenhobel Hand Skiver Rabot pour courroie	RTBS-F	0,06	23,00
	Bandschleifer Belt Grinder Meule pour bande	RB-1	0,34	106,00
	Bandhalter (Paar) Belt Grip (Pair) Poignée pour bande (la paire)	22	1,13	95,00
	Bandkebler Belt Grover Rabot pour bande	FBG1 HSP3	0,82 0,02	169,00 35,00
	Silikon Spray Silicone Spray Silicone	SL5-1	0,62	12,00

Locheisensatz Belt Punch Set Coffret de poinçons



Bestell-Nr. Order-No. No. de réf.	Gewicht Weight Poids kg	Preis Price Prix EUR
LS-1/06-24	1,36	488,00

Ersatz Locheisen / Spare Belt Punches / Poinçons de rechange

Bestell-Nr. Order-No. (No. de réf.)	Ø mm	Gewicht Weight Poids kg	Preis Price Prix EUR
L-06	6	0,06	45,40
L-08	8	0,06	45,40
L-10	10	0,06	45,40
L-12	12	0,12	49,70
L-14	14	0,12	49,70
L-16	16	0,12	49,70
L-18	18	0,18	54,40
L-20	20	0,18	54,40
L-22	22	0,18	54,40
L-24	24	0,18	54,40
L-26	26	0,25	85,20
L-28	28	0,25	85,20
L-30	30	0,25	85,20

FLEXCO
Abstreifer

FLEXCO
Belt Cleaners

FLEXCO
Racleurs



Kopfabstreifer / Precleaners / Pré-Racleurs

Modell Type Type	Bandbreite Belt Width Largeur de bande mm	Trommel-Ø Pulley-Ø Ø Tambour mm	Bandgeschwindigkeit Belt Speed Vitesse de la bande m/s	Blatt Blade Lame	Blattmaterial verbinderkompatibel? Blade material use with fasteners? Compatibilité avec agrafes?
EZP1	300 - 1800	250 - 900	< 3,6	Urethan(e)	Ja / Yes / Oui
MSP	600 - 2100	400 - 1050	< 3,6	Urethan(e)	Ja / Yes / Oui
MMP	600 - 2100	400 - 1200	< 5,1	Urethan(e)	Ja / Yes / Oui
MHCP	600 - 2100	500 - 1200	< 6,1	Urethan(e)	Ja / Yes / Oui
HXF	450 - 1800	250 - 1325	< 3,6	Urethan(e)	Ja / Yes / Oui
HV	450 - 1800	250 - 1575	< 5,1	Tungsten(e)	Nein / No / Non

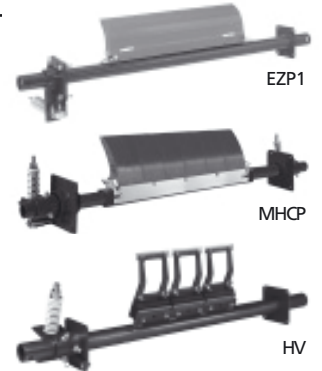

Sekundärabstreifer / Secondary Belt Cleaners / Racleurs secondaires

Modell Type Type	Bandbreite Belt Width Largeur de bande mm	Bandgeschwindigkeit Belt Speed Vitesse de la bande m/s	Blatt Blade Lame	Blattmaterial verbinderkompatibel? Blade material use with fasteners? Compatibilité avec agrafes?
EZS2	450 - 1800	< 3,6	Tungsten(e)	Ja / Yes / Oui
MSS-C	600 - 2100	< 6,1	Tungsten(e) C	Ja / Yes / Oui
MSS-V	600 - 2100	< 6,1	Tungsten(e) V	Nein / No / Non
MHS-C	600 - 2100	< 6,1	Tungsten(e) C	Ja / Yes / Oui
MHS-V	600 - 2100	< 6,1	Tungsten(e) V	Nein / No / Non
PC	450 - 3000	< 5,1	Tungsten(e) C	Ja / Yes / Oui
PV	450 - 3000	< 5,1	Tungsten(e) V	Nein / No / Non
RC	450 - 1800	< 5,1	Tungsten(e) C	Ja / Yes / Oui
RV	450 - 1800	< 5,1	Tungsten(e) V	Nein / No / Non



Abstreifer für Hochtemperaturbänder / High Temp Belt Cleaners / Racleurs pour bandes à haute température

Modell Type Type	Bandbreite Belt Width Largeur de bande mm	Temperatur Temperature Température °C	Bandgeschwindigkeit Belt Speed Vitesse de la bande m/s	Blatt Blade Lame	Blattmaterial verbinderkompatibel? Blade material use with fasteners? Compatibilité avec agrafes?
HTF	450 - 1800	160	< 3,6	Urethan(e)	Ja / Yes / Oui
HTF	600 - 2100	200	< 6,1	Tungsten(e) V	Nein / No / Non
HTS-C	600 - 2100	200	< 6,1	Tungsten(e) C	Ja / Yes / Oui



Abstreifer für Chevron Bänder / Chevron Belt Cleaners / Racleurs pour bandes à chevrons

Modell Type Type	Bandbreite Belt Width Largeur de Bande mm	Bandgeschwindigkeit Belt Speed Vitesse de la bande m/s	Blatt Blade Lame	Blattmaterial verbinderkompatibel? Blade material use with fasteners? Compatibilité avec agrafes?
CBC	500 - 1600	< 2,5		Ja / Yes / Oui



Pflugabstreifer / Plows / Chasse-pierres

Modell Type Type	Bandbreite Belt Width Largeur de bande mm	Bandgeschwindigkeit Belt Speed Vitesse de la bande m/s	Blatt Blade Lame	Blattmaterial verbinderkompatibel? Blade material use with fasteners? Compatibilité avec agrafes?
RDP1	450 - 2100	< 5,0	Diagonal	Ja / Yes / Oui
CBV	450 - 2400	< 5,0	V	Ja / Yes / Oui



Weitere Produkte

Gummi und Keramik Trommelbeläge
Gurtführungssysteme
Seitenabdichtungssysteme
Aufgabepallstationen

Other Products

Rubber and Ceramic Pulley Lagging
Belt Positioners
Skirt Clamps
Impact Beds

Autres Produits

Garnissages de tambour
Stations centrage pour bandes
Systèmes latéraux d'étanchéité
Barres d'impact

ANKER-FLEXCO GmbH
Leidringer Straße 40 - 42
D-72348 Rosenfeld

Telefon +49-74 28 - 94 06-0
Telefax +49-74 28 - 94 06-260
e-mail: info@anker-flexco.de
Internet: www.anker-flexco.de

**ANKER
FLEXCO**

TRANSPORTBAND-VERBINDUNGSSYSTEME
CONVEYOR BELT FASTENING SYSTEMS
SYSTÈMES D'AGRAFAGE POUR BANDES TRANSPORTEUSES